



SS792HFVD

SAFARI V-SPEC SNORKEL

To Suit: Toyota LandCruiser 70 series (MY24)
4.5L V8 Intercooled Turbo Diesel (1VD-FTV Engine)
(Replaces Factory Toyota Raised Air Intake)



01/12/2024

Parts List

ITEM	PART NO	DESCRIPTION	QTY
1	334-133-000	BODY - SNORKEL (SS792HFVD)	1
2	000-135-800	3.5" AIR RAM ASSEMBLY	1
3	334-032-100	BRACKET - UPPER MOUNTING	1
4	334-435-000	GASKET - RUBBER BRACKET	1
5	000-914/B	CLAMP - HOSE - BLACK	1
6	000-002-100	BOLT - HEX - 6mm x 1.0 x 14mm - SEMS	2
7	334-032-200	BRACKET - REAR MOUNTING (LOWER)	1
8	000-038-450	BOLT - TORX SCREW - 6mm x 1.0 x 12mm - Black S/S	2
9	000-442G	GROMMET - M8 - RUBBER	1
10	000-442S	FERRULE - M8 x 11.15mm Long - S/S	1
11	000-110	STUD - 8mm x 1.25 x 25mm - S/S	4
12	000-311-300	WASHER - BODY - 8mm x 30mm - S/S	4
13	000-205-300	NUT - NYLOC - 8mm x 1.25mm - S/S	4

14	334-024-200	HOSE - AIR ENTRY	1
15	000-909	CLAMP - HOSE - 80/100mm - S/S	1
16	000-910	CLAMP - HOSE - 90/110mm - S/S	1
17	334-017-000	TEMPLATE - GUARD PANEL	1



SS792HFVD

SAFARI V-SPEC SNORKEL

To Suit: Toyota LandCruiser 70 series (MY24)
4.5L V8 Intercooled Turbo Diesel (1VD-FTV Engine)
(Replaces Factory Toyota Raised Air Intake)

Installation Guide

Fitment to:

- Right Hand Side

Fitting Time:

- 120 min

Special Tools:

- Body Saw (Reciprocating)
- Step Drill
- Loctite 243 (Thread Lock)
- 6mm Spot weld drill / 6.5mm drill bit
- T30 Torx Drive
- Files / Grinder
- Masking Tape
- Touch-up Paint
- Sikaflex 227 Adhesive Sealant

Prior to commencing the installation, it is the installer's responsibility to verify that all components and particularly the guard panel template (Item 17) are correct.

1

Remove the following in accordance with the factory service manual:

- Air Cleaner Assembly

2

Remove and discard the Factory Toyota Raised Air Intake components (shown).

The following hardware must be retained,

- x2 A-pillar bracket mounting bolt assemblies (20mm long)
- Rear mounting bolt assembly (30mm long).



The front factory captive mounting nut assembly must be removed from the front RH guard panel.

The assembly is spot welded to the guard panel in two places. Firstly, identify where the assembly has been spot welded to the guard panel as the position of the spot welds may vary from vehicle to vehicle.

Drill a pilot hole in the centre of each spot weld and drill out the spot welds using a 6.5mm drill bit or spot weld drill bit. Use a small pry bar or flat blade screwdriver, on the backside of the guard panel, to break the spot welds from the guard panel and remove the nut assembly.

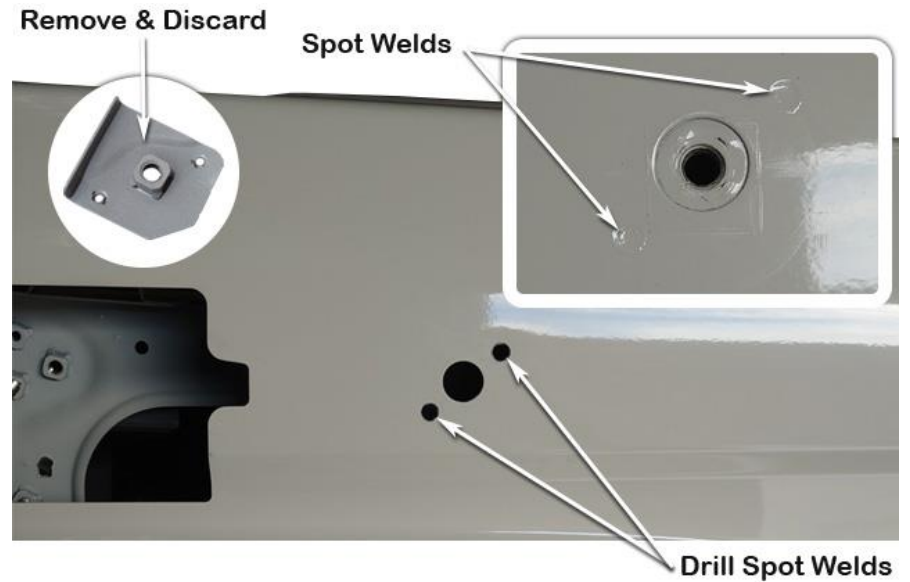

Remove and discard the perforated section from the guard panel template (item 17) as shown.

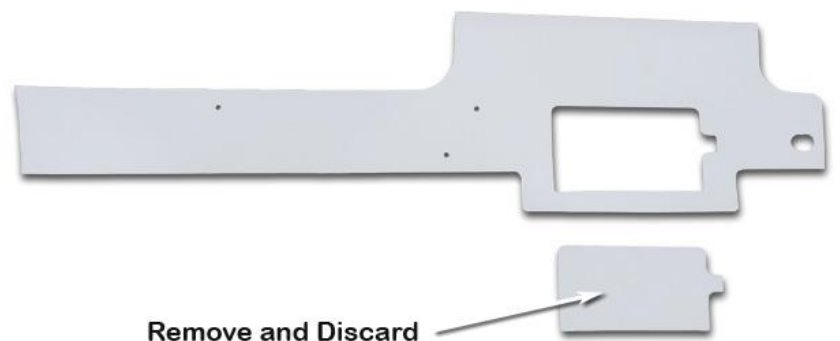

Align the guard panel template (Item 17) to the rear edge and upper edge of the guard panel.

Ensure to align the rear edge of the front template slot to the rear edge of the front factory hole of the guard panel as shown.

Tape the template to the guard panel with masking tape.

Mark all three hole positions and front slot profile with a felt tip pen.

Remove the template.

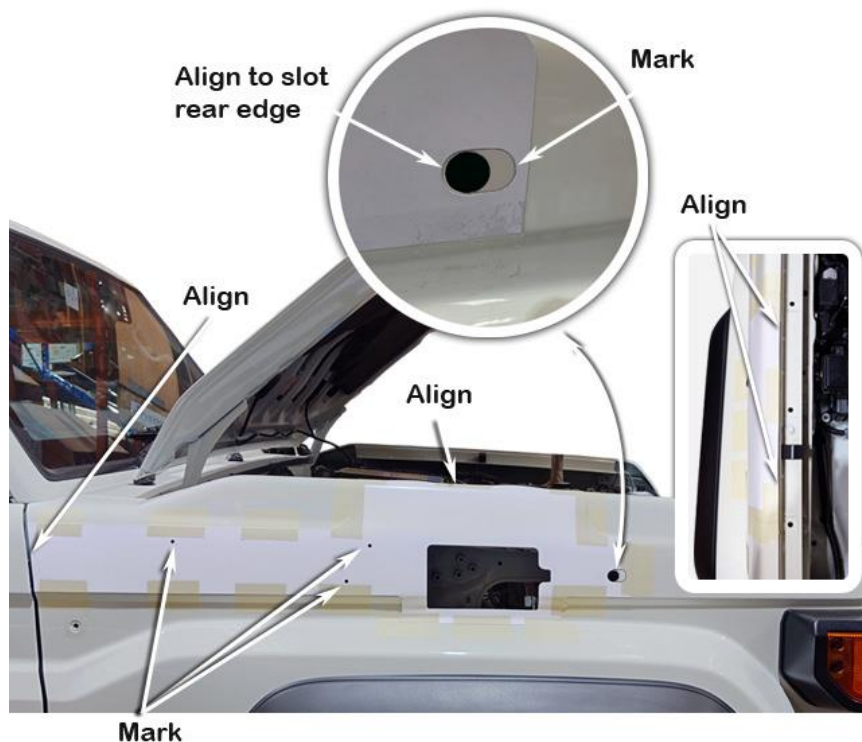

Drill a pilot hole at each of the marked hole positions.

Use a step drill to drill the three mounting hole positions to 16mm diameter.

Use a body saw to trim away the front marked slot on the guard panel as shown.

Deburr and paint all holes and cut sections of guard panel to prevent rust.

Hint: Prior to any cutting or drilling, place a strip of masking tape along the flare seal and guard panel to prevent metal filings being trapped between the seal and guard panel.



Install the upper mounting bracket (Item 3) to the snorkel body (Item 1), with the M6 Hex SEMS Bolts (Item 6).

Align the upper mounting bracket (Item 3) in the relief as shown and finger tighten the M6 Hex SEMS bolts (Item 6).

Apply Loctite 243 to each of the stainless-steel mounting studs (Item 11) and install the studs finger tight into the snorkel body (Item 1) mounting inserts as shown.

Apply Loctite 243 to the remaining two M6 x 12mm Torx bolts (Item 8) and secure the rear mounting bracket (Item 7) to the snorkel body as shown.

Install the rubber grommet (Item 9) into the lower mounting bracket (Item 7) with the thicker side of the grommet facing the panel side of the snorkel body.

Install the stainless steel ferrule (Item 10) into the grommet as shown.

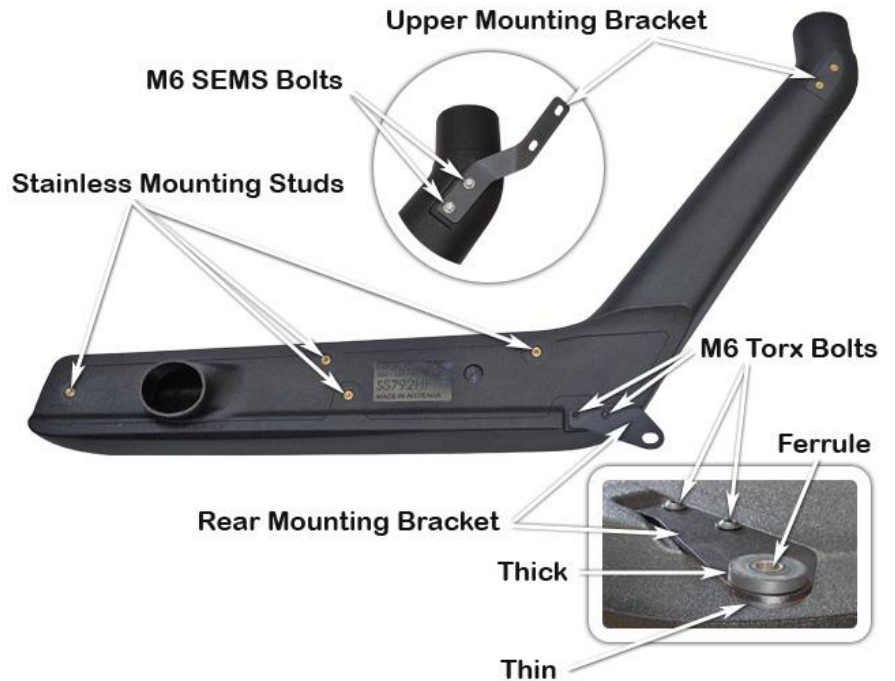

Carefully install the snorkel body (Item 1) to the guard panel.

When correctly aligned, fasten the snorkel body to the guard panel with the body washers (Item 12) and nyloc nuts (Item 13).

Fasten the rear mounting bracket (Item 7) using the 30mm long genuine Toyota rear mounting bolt assembly retained in step 2.



Position the rubber bracket gasket (Item 4) between the upper mounting bracket (Item 3) and A 'Pillar panel. Ensure gasket is aligned to the x2 factory captive nut locations in the vehicle A 'Pillar.

Secure the upper mounting bracket (Item 3) to the A 'Pillar using the x2 20mm long genuine Toyota A-pillar bracket mounting bolts retained in Step 2.

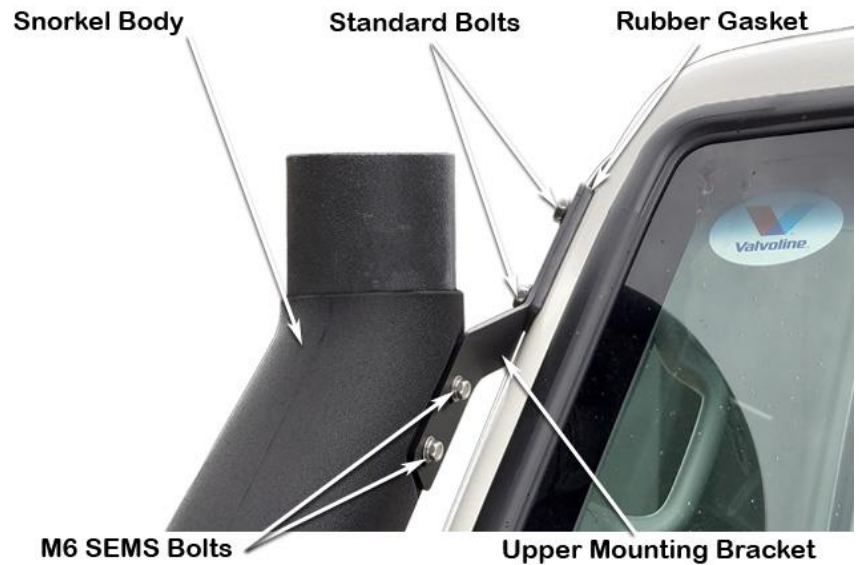

Loosely install the black hose clamp (Item 5) to the base of the Air Ram Assy (Item 2).

Install the Air Ram Assy onto the Snorkel Body (Item 1).

Align the Air Ram and tighten the black hose clamp (Item 5).



INSTALLER OPTION :

The air cleaner housing base contains a drain valve as shown. The drain valve can permit water to enter the air intake.

Safari advises that the drain valve should be sealed to ensure a watertight installation.



Loosely install the 90/110mm hose clamp (Item 16) loosely over the air entry hose (Item 14).

Note the orientation of the hose clamp.

Install the air entry hose (Item 14) onto the snorkel body outlet snout.

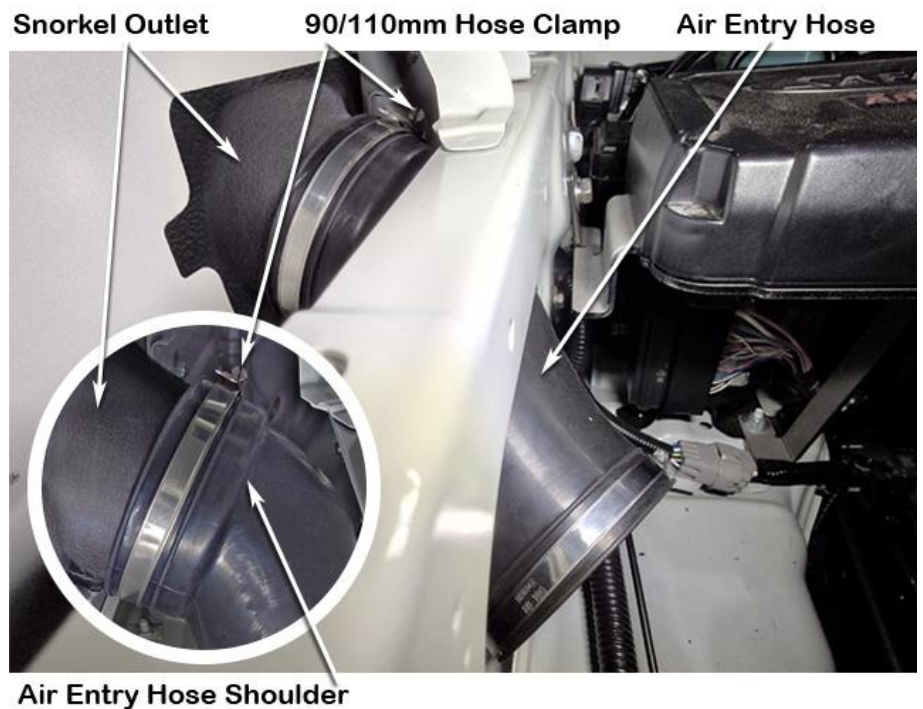

13

Loosely install the 80/100mm hose clamp (Item 15) onto the air entry hose (Item 14).

Note the orientation of the hose clamp

Install the air cleaner base back into position guiding the air cleaner inlet snout into the air entry hose (Item 14).

Fasten the air cleaner base with the original mounting hardware.

Fully tighten both the 80/100mm & 90/110mm hose clamps (Item 15 & 16).

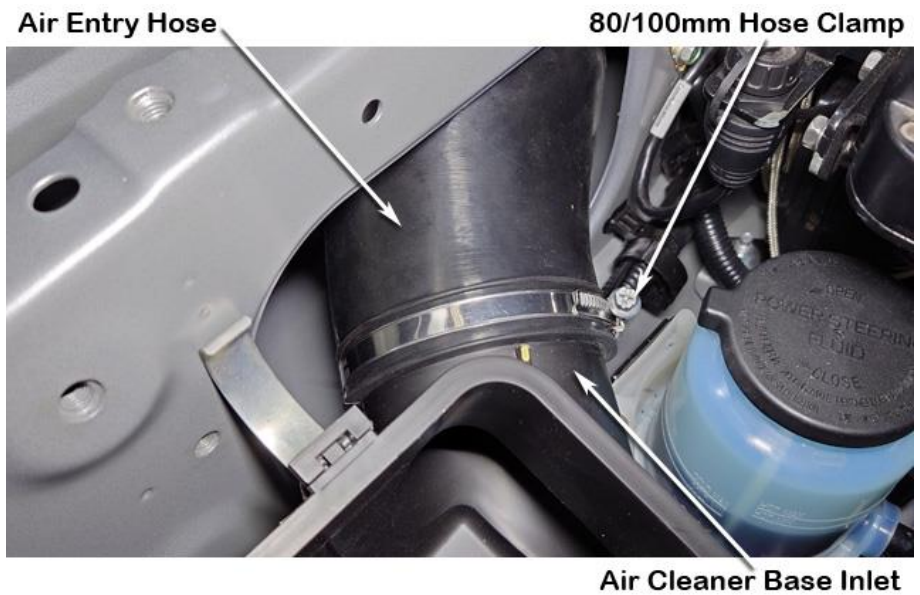

14

Install the standard air filter element, air cleaner lid and any additional components that may have been removed during the snorkel installation process.

15 **N.B: It is the installer's responsibility to ensure that all connections are watertight.**