



ARMAX

SS98HP

SAFARI ARMAX SNORKEL

To Suit: Toyota LandCruiser 300 Series (MY22)

3.3L V6 Twin Turbo Diesel (F33A-FTV Engine)

N.B: Does Not Suit Models with Factory Raised Air Intake (Snorkel)

N.B: Not compatible with some manufacturers side rails



01/11/2023

Parts List

ITEM	PART NO.	DESCRIPTION	QTY
1	371-133-600	BODY - SNORKEL (SS98HP)	1
2	000-135-980	ARMAX AIR RAM ASSEMBLY	1
3	371-032-600	BRACKET - UPPER MOUNTING	1
4	000-002-100	BOLT - HEX - 6mm x 1.0 x 14mm (SEMS) - S/S	2
5	000-951-300	SCREW - S/T - 4.2mm x 16mm - S/S	3
6	000-960	INSERT - PLASTIC	3
7	000-110	STUD - 8mm x 1.25 x 25mm - S/S	6
8	000-311-300	WASHER - BODY - 8mm x 30mm - S/S	6
9	000-205-300	NUT - NYLOC - 8mm x 1.25mm - S/S	6
10	371-024-600	HOSE - SNORKEL OUTLET	1
11	371-025-700	JOINER - 101.6mm dia x 40mm Long - S/S	1
12	371-024-700	HOSE - AIR CLEANER ENTRY (Flanged)	1
13	371-025-600	PLATE - HOSE SUPPORT - S/S (Side)	1
14	371-025-625	PLATE - HOSE SUPPORT - S/S (Front)	1
15	371-025-650	PLATE - HOSE SUPPORT - S/S (Bottom)	1
16	371-025-675	PLATE - HOSE SUPPORT - S/S (Lower)	1

17	371-025-725	PLATE - HOSE SUPPORT - S/S (Small)	1
18	000-958-175	POP RIVET - 4mm x 17mm	15
19	000-300-350	WASHER - BODY - 4mm x 12mm - S/S	6
20	371-442-600	ISOLATOR - AIR CLEANER MOUNTING	3
21	000-1911	CLAMP - HOSE - 100/120mm - S/S	2
22	000-1917	CLAMP - HOSE - 160/180mm - S/S	1
23	371-967-600	PLATE - INNER GUARD SUPPORT - S/S (Pressed)	1
24	000-022	BOLT - HEX - 5.0mm x 0.8 x 16mm	4
25	000-320-100	WASHER - FLAT - 5.0mm x 15mm	8
26	000-221	NUT - NYLOC - 5.0mm x 0.8mm	4
27	000-958-625	POP RIVET - 4.8mm x 10mm (Black Anodised)	3
28	000-951-480	SCREW - S/T - 4.2mm x 13mm - (Black)	4
29	371-888-000	SONOFLEX DUCTING - 90mm ID x 127mm	1
30	371-217-600	TEMPLATE - AIR CLEANER (Side)	1
31	371-217-625	TEMPLATE - AIR CLEANER (Front)	1
32	371-217-650	TEMPLATE - AIR CLEANER (Lower)	1
33	371-017-700	TEMPLATE - INNER GUARD PANEL	1
34	371-017-600	TEMPLATE - GUARD PANEL	1



SS98HP

SAFARI ARMAX SNORKEL

To Suit: Toyota LandCruiser 300 Series (MY22)
3.3L V6 Twin Turbo Diesel (F33A-FTV Engine)

N.B: Does Not Suit Models with Factory Raised Air Intake (Snorkel)
N.B: Not compatible with some manufacturers side rails

Installation Guide

Fitment to:

- Left Hand Side

Fitting Time:

- 240min

Special Tools:

- Body saw (reciprocating)
- Step drill
- Die Grinder
- 2.0, 4.5, 5.0 & 5.5mm Drill Bits
- Pop Rivet Gun
- Sikaflex 227 adhesive sealant
- CRC Spray Lubricant
- Knife / Chisel
- Masking tape
- Loctite 243 (thread lock)
- Touch-up paint
- Prep-wash

Prior to commencing the installation, it is the installer's responsibility to verify that all components and particularly the template (Item 34) are correct.

1

Remove the LHS mud flap, inner guard liner and the air cleaner assembly in accordance with the factory service manual.

2

Remove and retain the top plastic guard panel trim and Inner guard plastic intake insulator (shown).

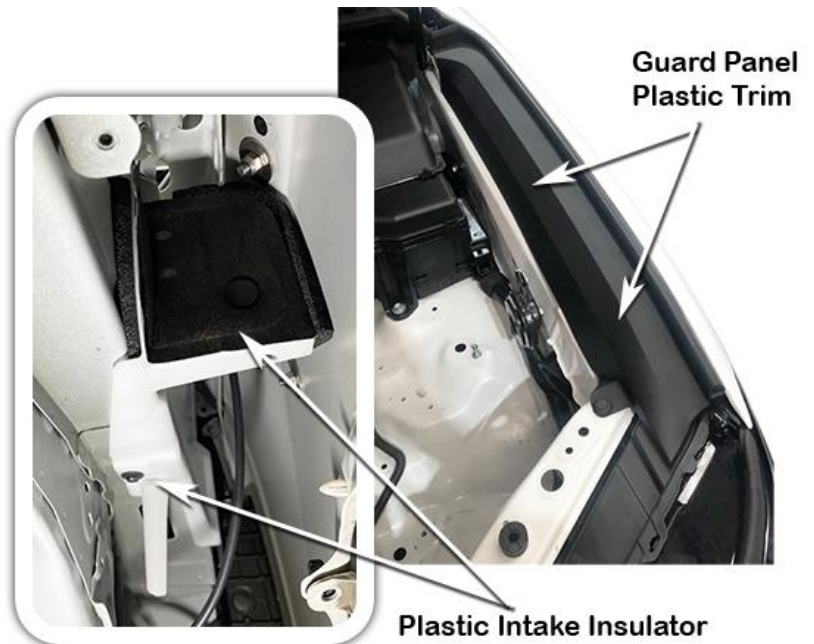

3

Remove and discard the standard air entry ducting (shown).

Retain the two 6mm x 25mm sems bolts from the inner guard duct.



4

Remove and discard the three perforated sections of the guard panel template (item 34) as shown.

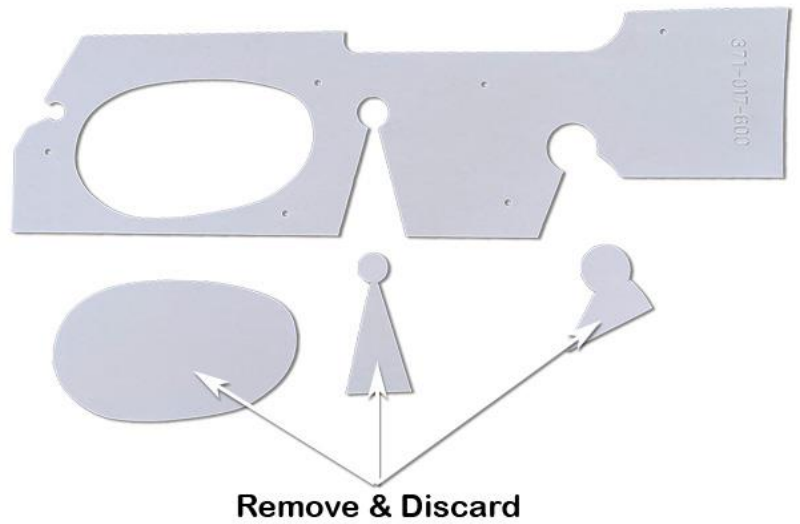

5

Align the guard panel template (item 34) to the top and rear edges of the left hand guard panel as shown.

Tape the template to the guard with masking tape.

Mark all hole positions and the main cut out section with a felt tip pen.

Remove the template.

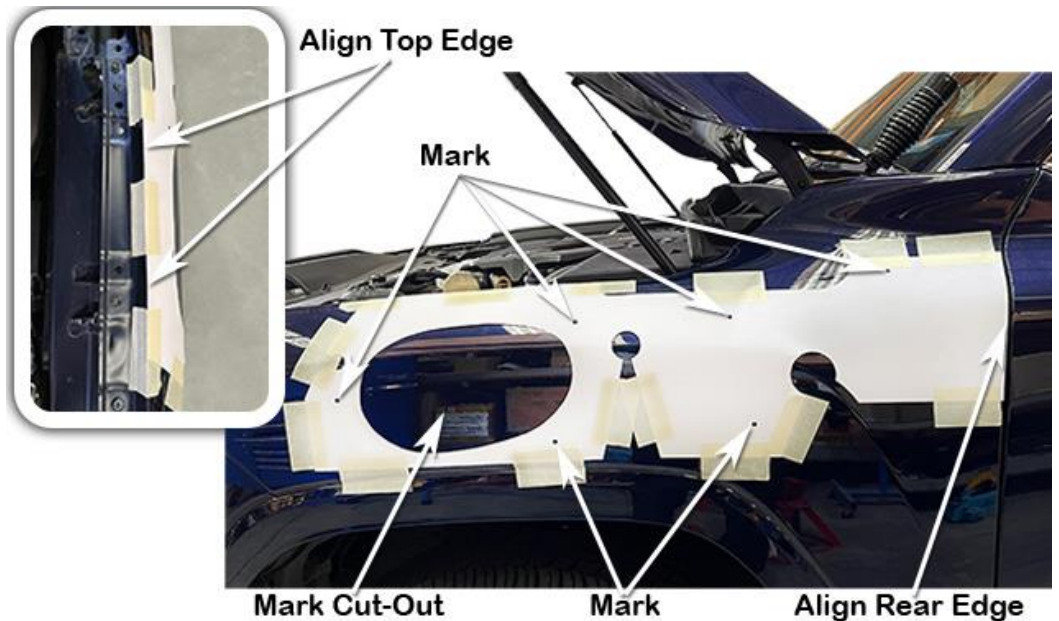

Drill a pilot hole for each of the marked hole positions.

Use a step drill to drill the six mounting holes to 16mm diameter.

Drill 1 or 2, 10mm diameter holes in the cut-out section for a start/stop point for the body saw, using the body saw cut the main hole in the guard panel, as marked from the template cut-out in step 5.

Deburr and paint all holes and the cut section of guard panel.

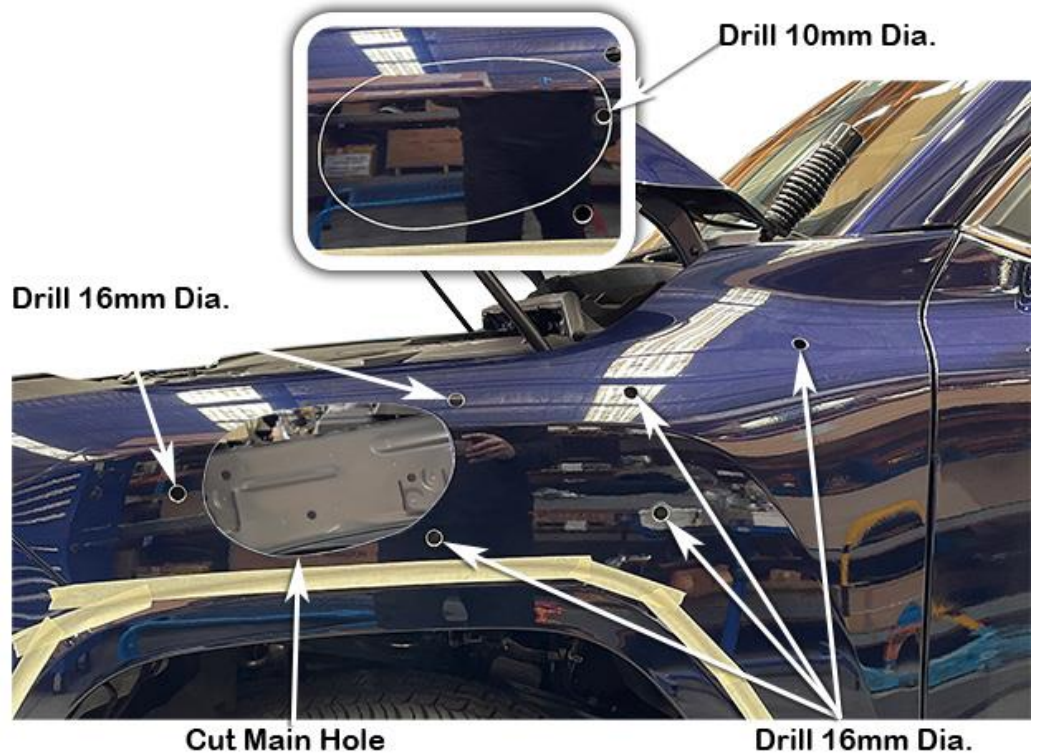

Locate and mark the centres of the two spot welds of the front inner guard duct mounting bracket.

Using a die grinder, grind out the two spot welds and remove the mounting bracket from the inner guard rail, as shown.

Deburr and paint the inner guard rail to prevent rust.

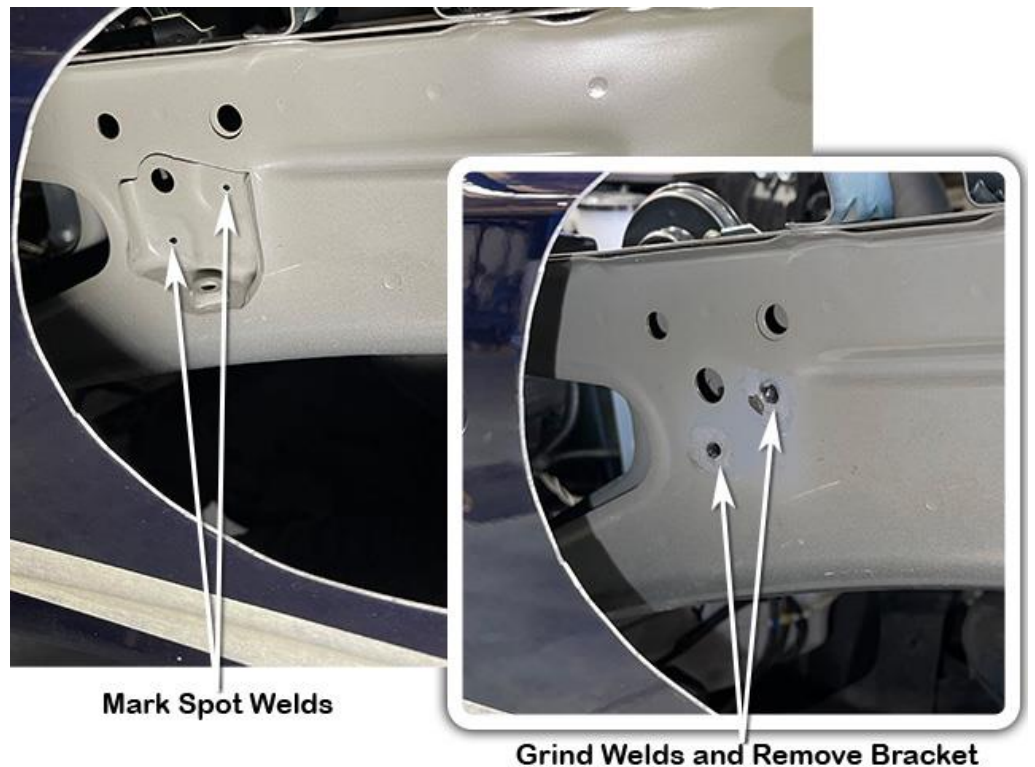

NEW ZEALAND INSTALLATIONS ONLY :

Safari have developed 2 methods of Snorkel A pillar attachment, for the conventional method please proceed with the current document alternatively please see the link below for further instructions.

www.safari4x4.co.nz/apillarmounting

8

Install the upper mounting bracket (item 3) to the snorkel body (item 1) with hex bolts (item 4).

Apply Loctite 243 to each of the stainless steel mounting studs (item 7) and install the studs finger tight into the snorkel body (item 1) mounting inserts as shown.

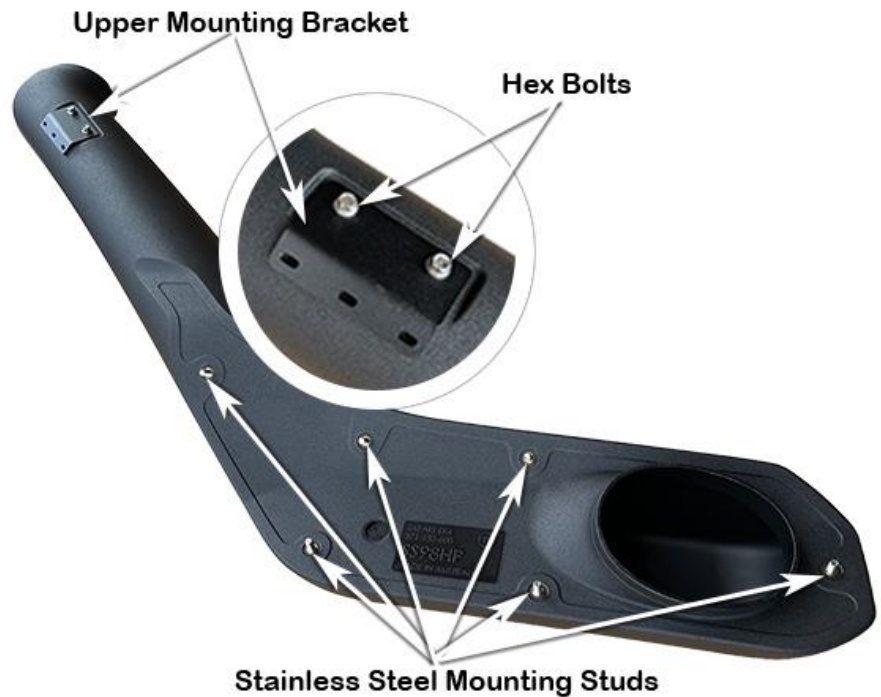

9

Locate the four dimples around the inlet of the Snorkel body.

Drill a 2.0mm hole at each of the four dimple locations as shown.

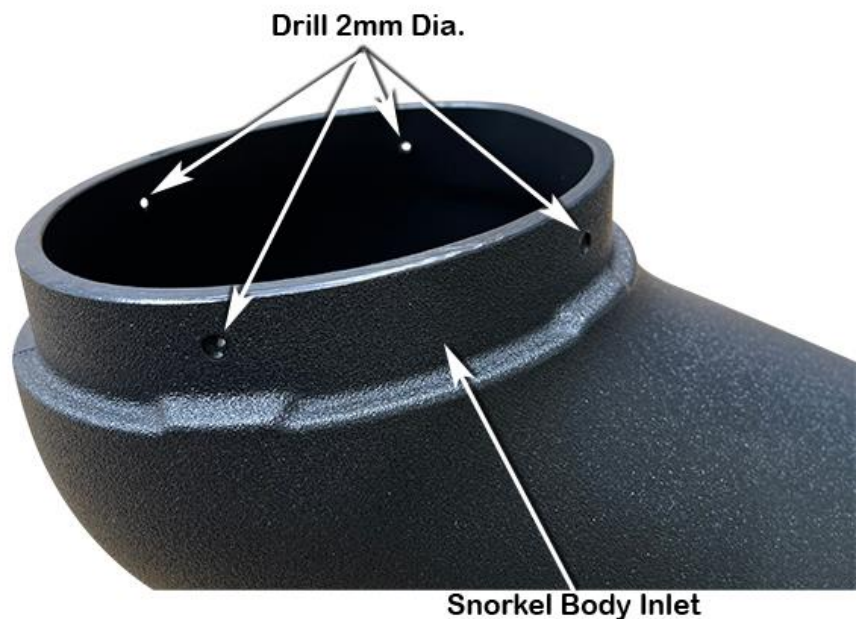

Place a strip of masking tape along the A-Pillar panel.

Carefully install the snorkel body (item 1) to the guard panel.

With the snorkel body correctly positioned, mark the outline of the upper mounting bracket (item 3) onto the masking tape.

Marked Bracket Position

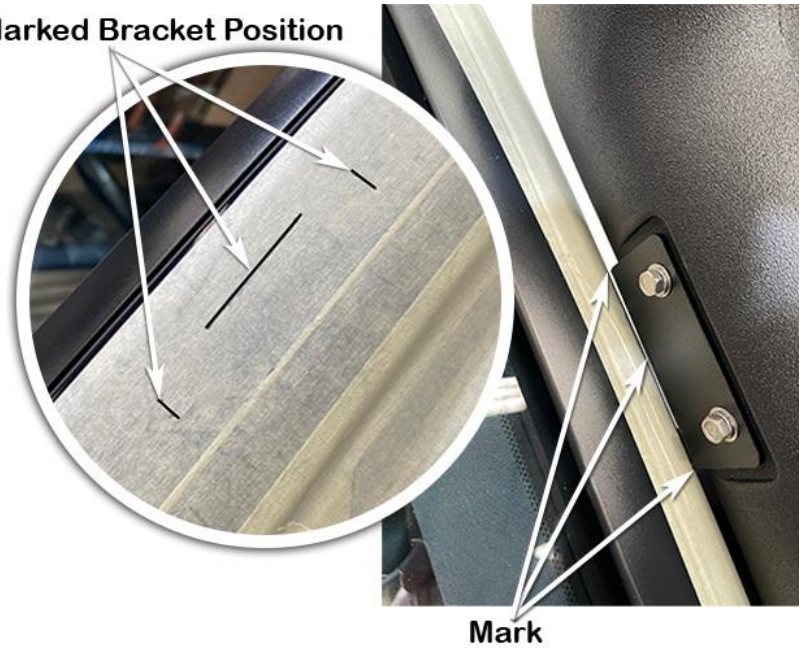

Remove the snorkel body (item 1) from the vehicle, remove the upper mounting bracket (item 3) from the snorkel body.

Position the upper mounting bracket onto the A-Pillar and align the bracket with the marked bracket outline.

Mark the three slotted mounting hole positions with a felt tip pen.

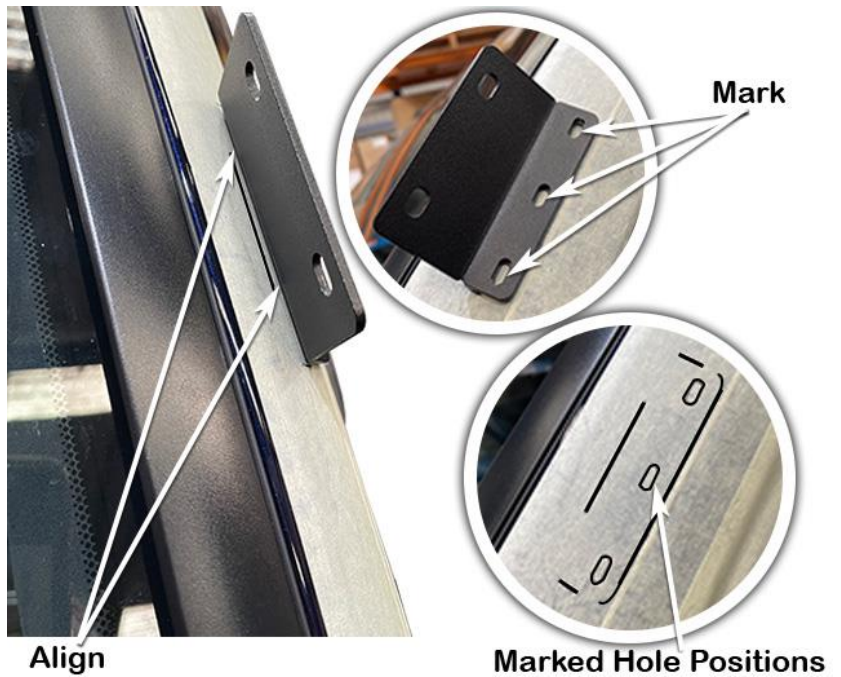

12

Drill a pilot hole in the centre of the three marked slotted hole positions. Drill each pilot hole to 8mm diameter with a step drill or 8mm drill bit.

Deburr and paint holes.

Drill 8mm Dia.

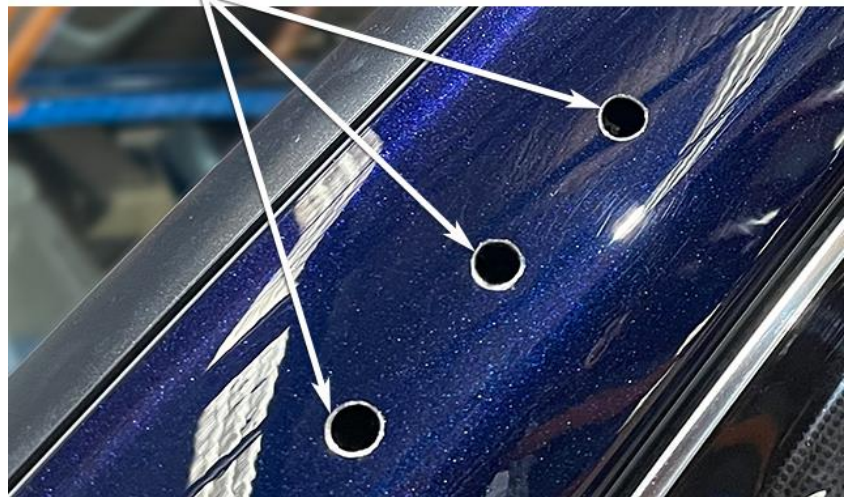

13

Install the plastic inserts (item 6) into the 8mm diameter holes in the A-pillar.

Secure the upper mounting bracket (item 3) to the A-pillar with three 4.2 x 16mm self-tapping screws (item 5).

Plastic Inserts



Upper Mounting Bracket

Self Tapping Screws

14

Remove and discard the two loom mounting cable ties shown from the main wiring harness to allow the wiring harness to drop down.

Remove the horn from the inner guard panel.

Remove & Discard



15

Align the inner guard panel template (item 33), to the two captive 6.0mm nuts in the inner guard panel as shown, using two 6.0mm bolts fasten the template to the inner guard panel.

With the template correctly aligned, mark the cut-out section onto the inner guard panel using a felt tip pen.

Remove the template.

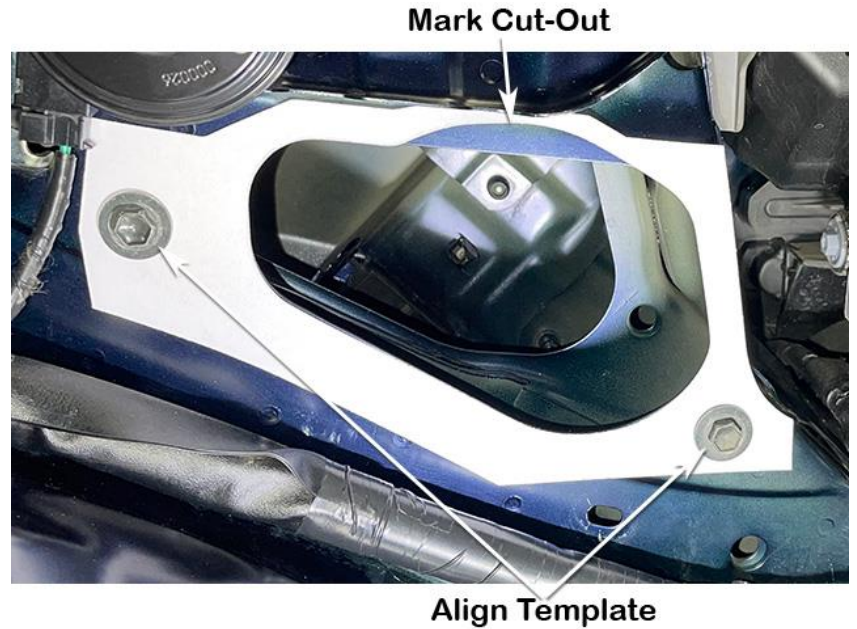

16

Align the inner guard support plate (item 23), to the two captive 6.0mm nuts in the inner guard panel as shown, using two 6.0mm bolts, fasten the support plate to the inner guard panel.

With the support plate correctly fastened and aligned to the inner guard panel, mark the cut-out section using a felt tip pen, using a 5.0mm drill bit drill the seven mounting holes.

N.B: The four upper holes need to be drilled through multiple panels, the three lower holes need to be drilled only into the cavity section of the inner guard.

Remove the inner guard support plate.

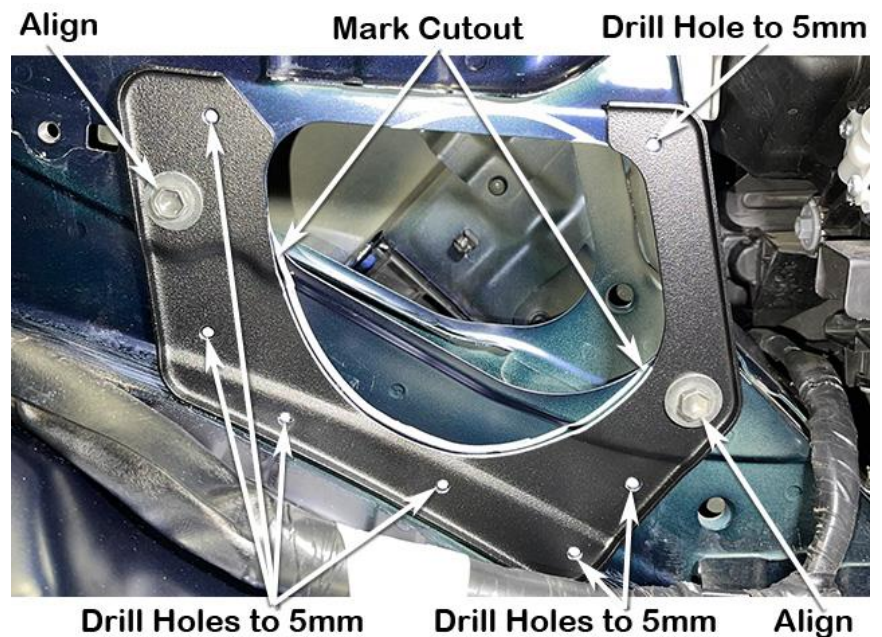

Using a 5.5mm drill bit, drill the four upper holes to 5.5mm diameter.

Using the body saw cut the upper and lower cut-out sections marked in steps 15 & 16.

Deburr and paint all cut and drilled sections of the inner guard panel.

Cut Upper & Lower Sections Drill Holes To 5.5mm



Drill Holes To 5.5mm

Apply Sikaflex Sealant to the back of the inner guard support plate (item 23), install the plate to the inner guard panel, loosely install the two 6.0 x 25mm sems bolts retained in step 3 into the two captive 6.0mm nuts, install the 5.0 x 16mm bolts (item 24) with 5.0mm washers (item 25) installed into the four upper mounting holes, loosely install a 5.0mm washer (item 25) and 5.0mm nyloc nut (item 26) onto the bolts, install the 4.8mm pop rivets (item 27) into the three lower holes.

With all the fasteners installed, tighten the two 6.0 x 25mm sems bolts, using a pop rivet gun secure the three pop rivets and then tighten the four 5.0 x 16mm bolts.

Cleanup any excess Sikaflex to ensure a neat finish.

Apply Sikaflex 227



Install 4.8mm Pop Rivets

5mm Nyloc Nut & 5mm Flat Washer



Inner Guard Support Plate Secure 4.8mm Pop Rivets

Remove and discard the foam sealing tape from the air cleaner base inlet snout.



Using a chisel or sharp knife remove the two small ribs from the top of the air cleaner base inlet snout.

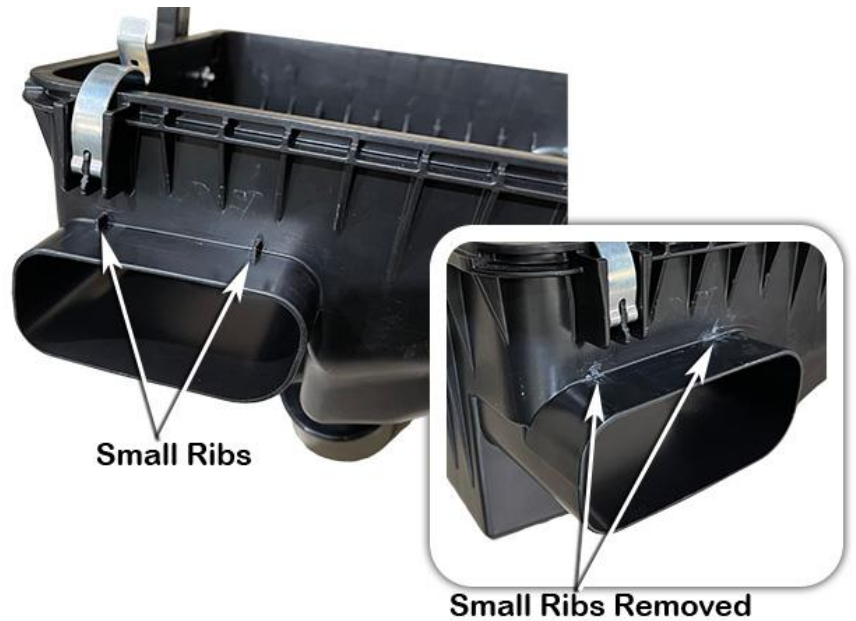

Using a hacksaw blade carefully cut off the air cleaner base inlet snout flush with the air cleaner base as shown.



Using a chisel or sharp knife, shorten the five highlighted external ribs on the side of the air cleaner base to a total length of 15mm, as shown.

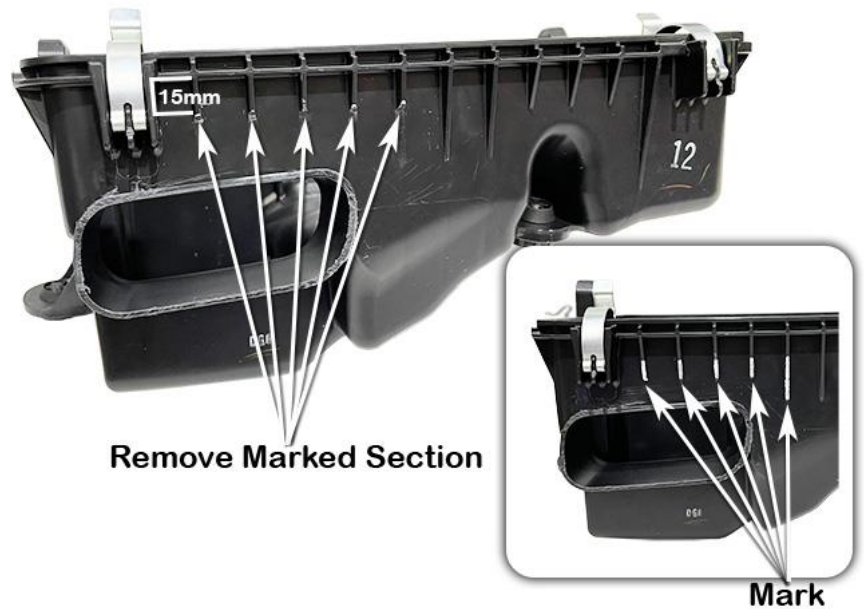

Using a chisel or sharp knife, shorten the three highlighted external ribs from the front corner of the air cleaner base to a total length of 15mm, as shown.

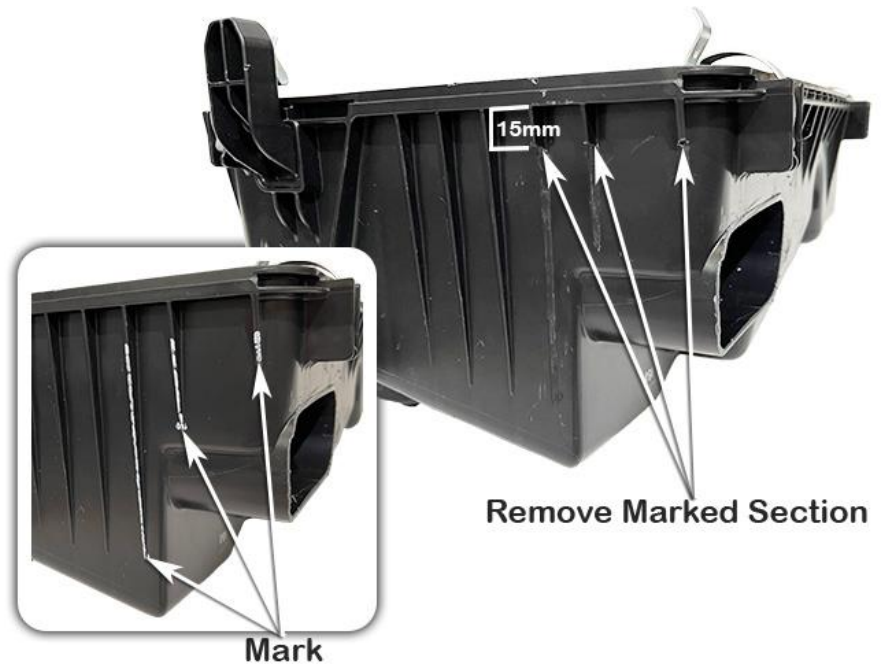

Neatly apply masking tape to the side, front corner and underside of the air cleaner base, as shown.



Align the air cleaner side template (item 30) under the top lip and to the side rib of the air cleaner base, tape with masking tape to hold the template in position.

Using a ball point pen mark the five hole locations and the cutting line onto the masking tape.

Remove the template.

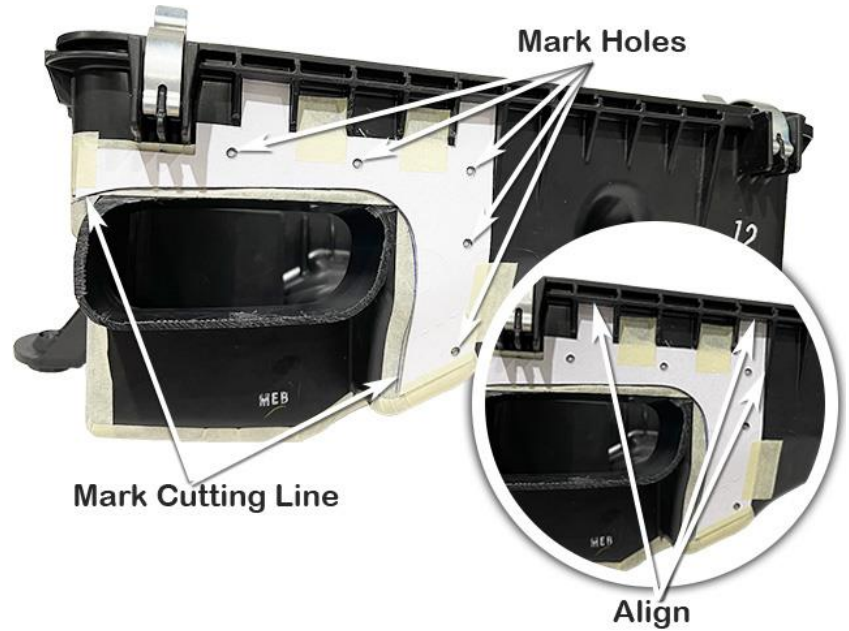

Align the air cleaner front template (item 31) up under the top lip and to the rib of the air cleaner base, tape with masking tape to hold the template in position.

Using a ball point pen mark the four hole locations and the cutting line onto the masking tape.

Remove the template.

Note: The top lip of the air cleaner base is hollowed out, ensure the template is install right to top of the lip.

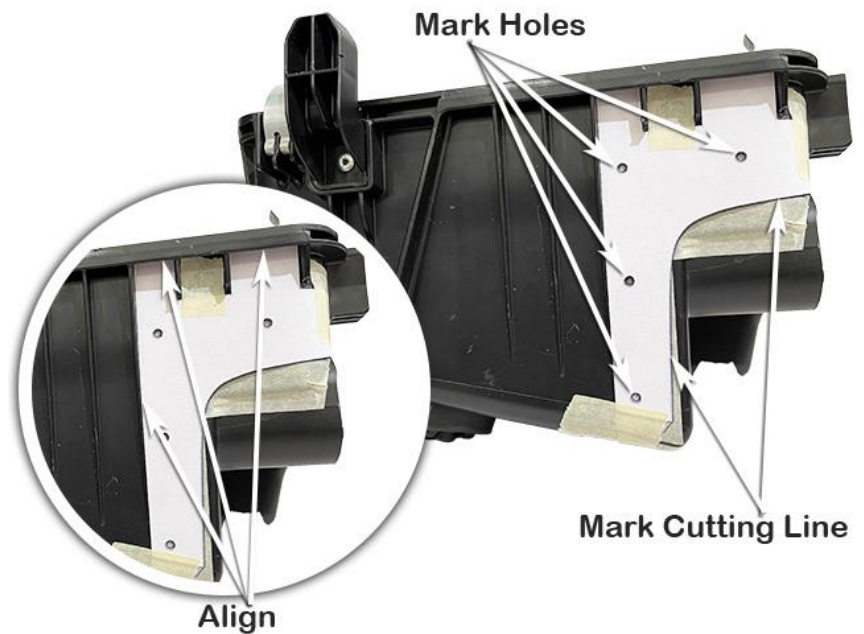

Remove and retain the drain valve from the air cleaner base.

Align the air cleaner base lower template (item 32) around the air cleaner base drain hole aligning the template to two flat sections of the air cleaner base drain valve hole, tape with masking tape to hold the template in position.

Using a ball point pen mark the six hole locations and the cutting line onto the masking tape.

Remove the template.



Drill a pilot hole at each of the fifteen marked hole positions, using a 4.5mm drill bit drill the fifteen pilot holes to 4.5mm diameter.



Using the body saw carefully cut the new air cleaner base inlet hole as marked from the templates in steps 25, 26 & 27.

Deburr the cut edge and all drilled holes.

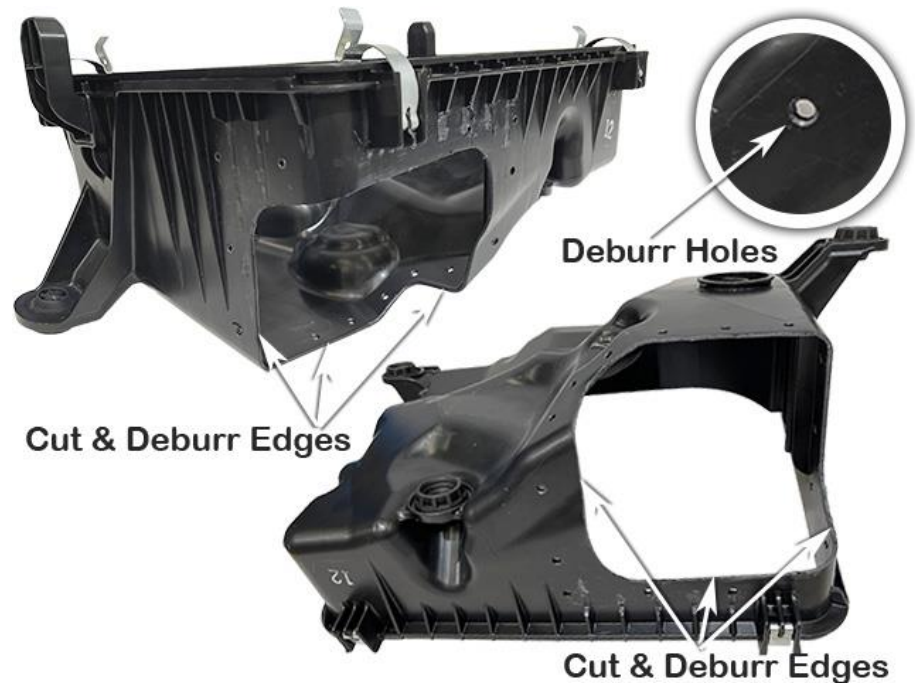

The side hose support plate (item 13), the end section of the support plate needs to be bent down by 3.0 – 4.0mm approximately as shown.

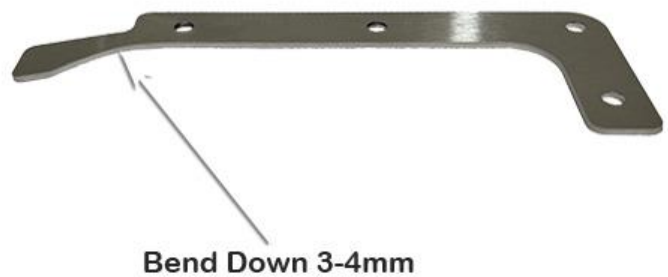

Apply Sikaflex sealant to the air cleaner base and install the flanged air cleaner entry hose (item 12) to the air cleaner base.

Install the side hose support plate (item 13) to the flanged hose and install the 4mm x 17mm pop rivets (item 18) from the inside of the air cleaner base as shown.

With the four pop rivets install through the support plate, secure using a pop rivet gun.

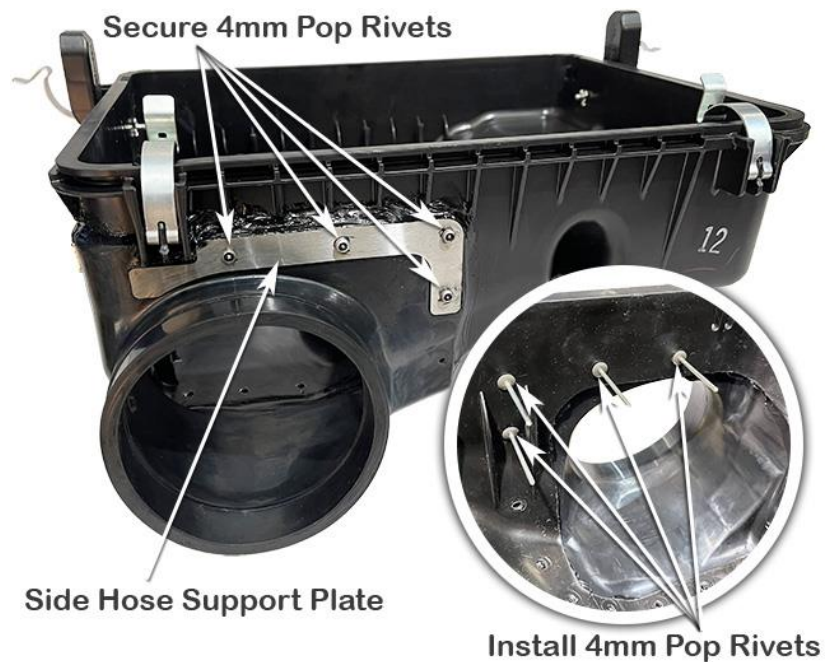

Install the front hose support plate (item 14) to the flanged hose and install the 4mm x 17mm pop rivets (item 18) from the inside of the air cleaner base as shown.

With the four pop rivets install through the support plate, secure using a pop rivet gun.

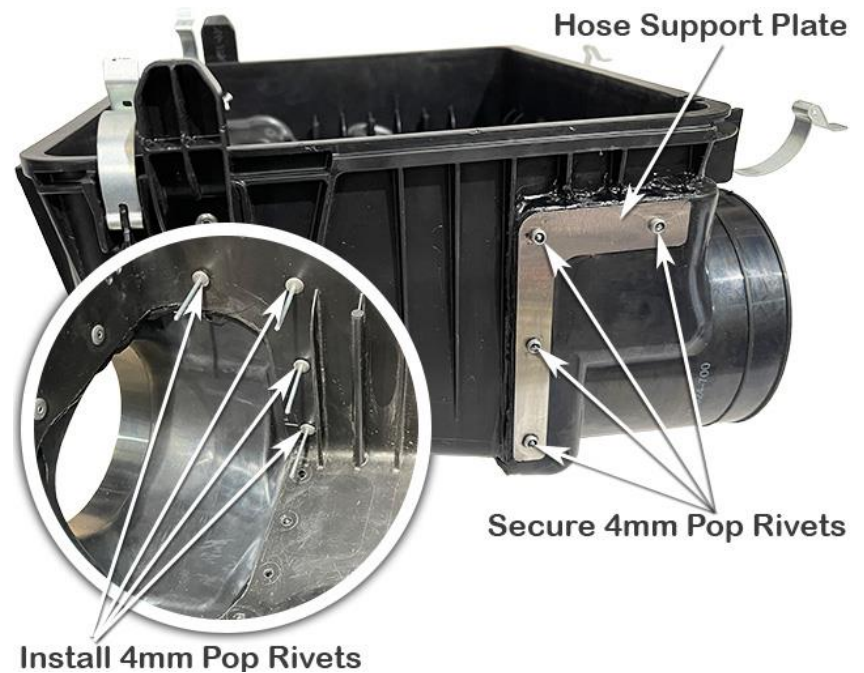

Install the small hose support plate (item 17) to the flanged hose and install the 4mm x 17mm pop rivet (item 18) from the inside of the air cleaner base as shown.

With the pop rivet install through the support plate, secure using a pop rivet gun.

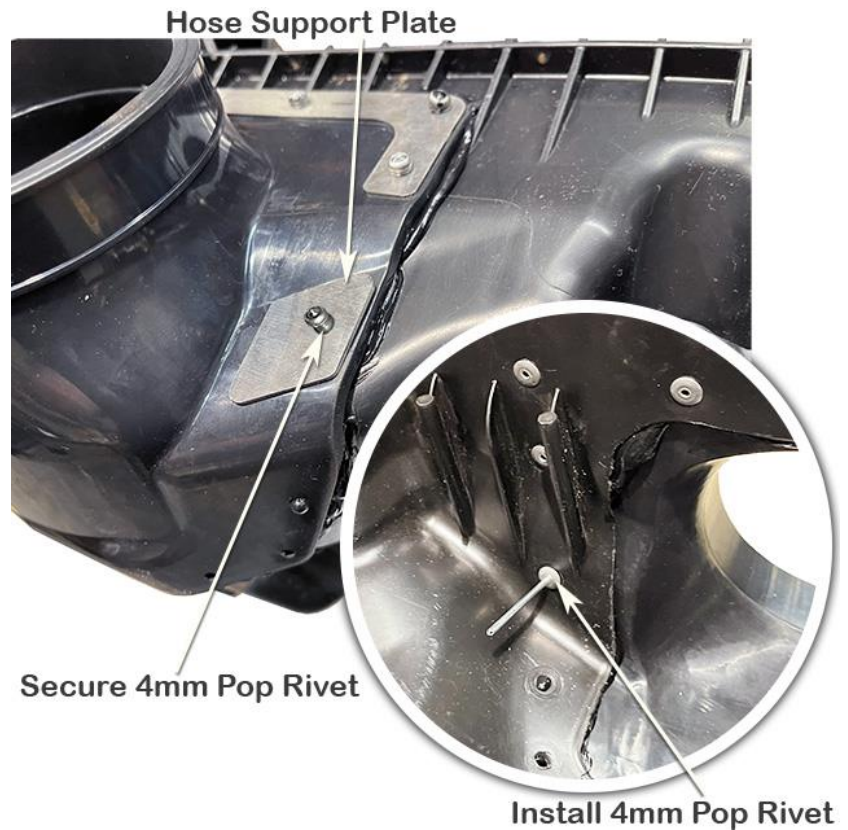

Install the bottom and lower hose support plates (items 15 & 16) to the flanged hose, install the 4mm x 17mm pop rivets (item 18) from the outside of the air cleaner base through the plates and hose and into the air cleaner base as shown.

With the six pop rivets installed, place a 4.0mm washer (item 19) over the end of each pop rivet as shown, secure the pop rivets with the washer installed using a pop rivet gun.

Clean up any excess Sikaflex to ensure a neat finish.



35

INSTALLER OPTION

The air cleaner base contains a drain valve as shown. The drain valve can permit water to enter the air intake.

Safari advises that the drain valve should be sealed to ensure a watertight installation.

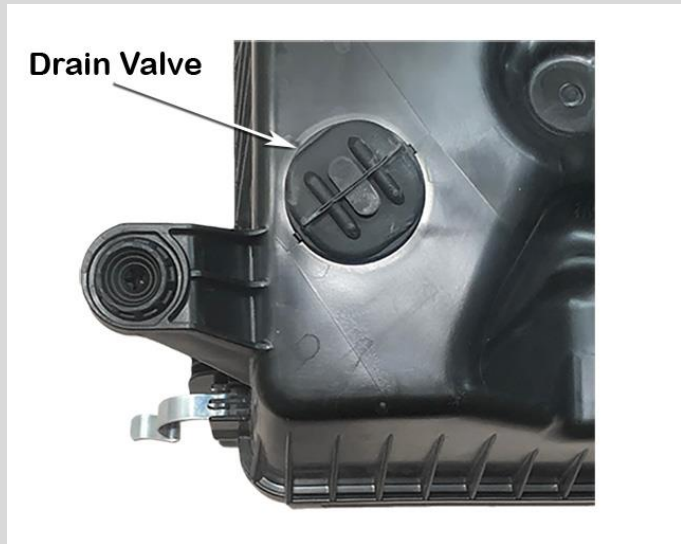

36

INSTALLER OPTION

The air cleaner base has two factory brackets which are secured to the air cleaner base with pop rivets as shown. The pop rivets can permit water to enter the air intake.

Safari advises that the pop rivets should be sealed to ensure a watertight installation.



37

Remove and discard the three standard air cleaner base mounting isolators.

Apply a small amount of CRC lubricant to each of the three new air cleaner base mounting isolators (item 20) supplied in the kit, install the new isolators into the air cleaner base mount holes.



Squash the end of the snorkel outlet hose (item 10) inwards and tape to hold in position.

N.B: it is critical the hose is taped the way shown in the photo, for installation purposes.

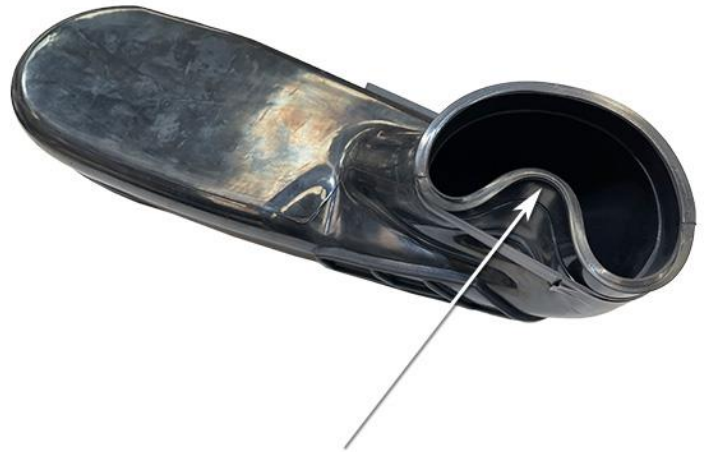

Tape Snorkel Outlet Hose Inwards

Carefully install the snorkel outlet hose (item 10) through the two inner guard panel holes installing the hose from the inner guard side, guiding the hose where required through the two inner guard panel holes.

Remove the tape from the end of the hose.



Snorkel Outlet Hose

Tape Removed

Shape the 160/180mm hose clamp (item 22) to the oval shape of the snorkel outlet hose (item 10), loosely install the hose clamp onto the hose.

N.B: Hose clamp orientation

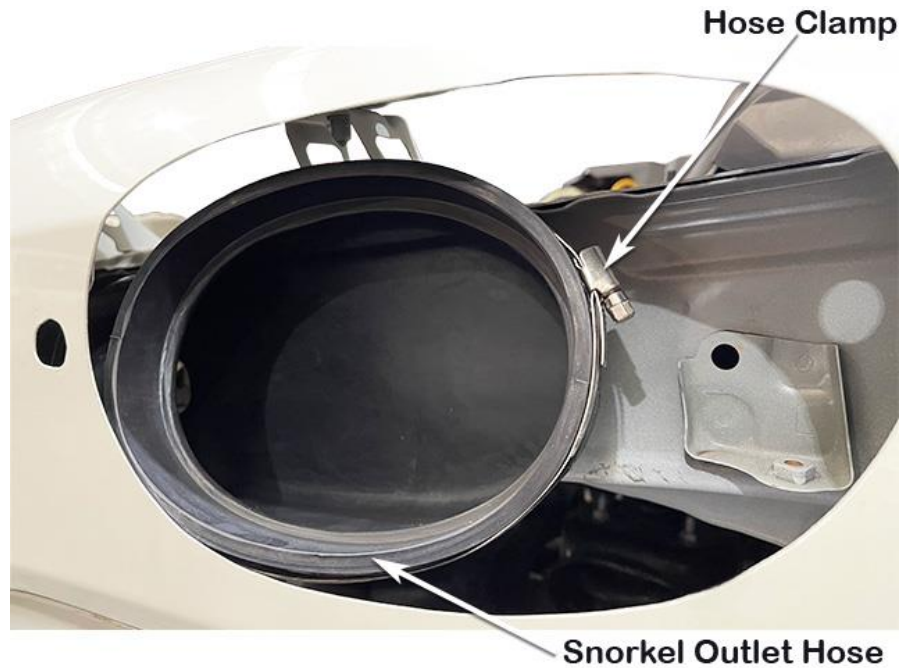

Carefully install the snorkel body (item 1) to the guard panel, guiding the snorkel body outlet into the snorkel outlet hose (item 10), align the snorkel body to guard panel and upper mounting bracket.

When correctly aligned, fasten the snorkel body to the guard panel with body washers (item 8) and nyloc nuts (item 9).

Fasten the snorkel body to the upper mounting bracket with hex bolts (item 4).



Loosely install the 100/120mm hose clamp (item 21) onto the snorkel body outlet hose (item 10), install the stainless steel joiner (item 11) into the end of the hose and fasten the 100/120mm hose clamp.

N.B: Ensure that the hose clamp is orientated in the same position on the hose as shown.



Hose Clamp

Stainless Steel Joiner

Loosely install the 100/120mm hose clamp onto the flanged air cleaner entry hose, carefully install the air cleaner base, guiding the air cleaner entry hose (item 12) over the stainless steel joiner.

Carefully push the air cleaner base mounting isolators over the three mounting pins.

Ensure the stainless steel joiner is correctly installed into the hose and tighten the 100/120mm hose clamp.

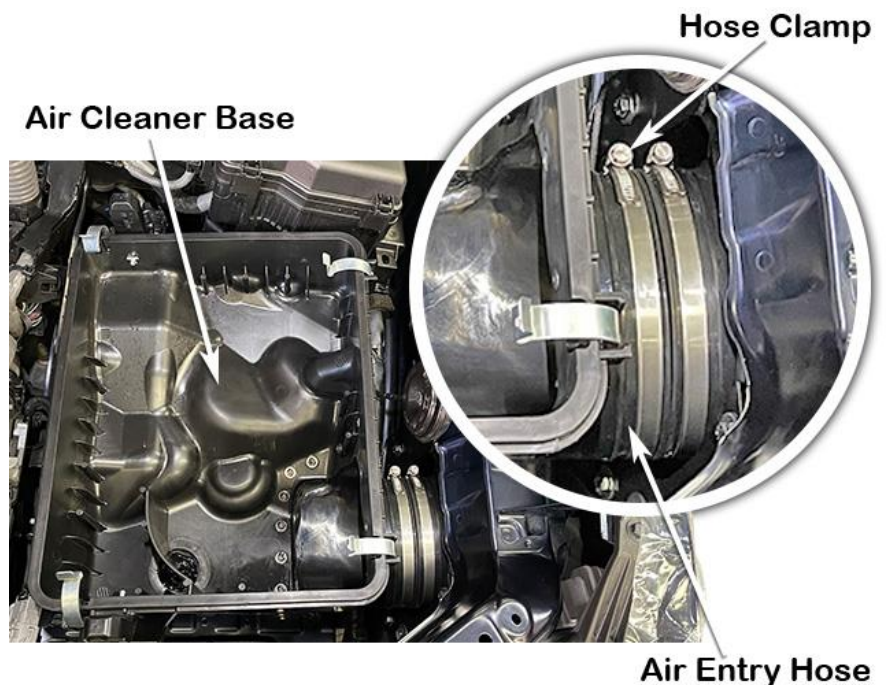

Air Cleaner Base

Hose Clamp

Air Entry Hose

Ensure the snorkel outlet hose (item 10) is correctly install onto the snorkel body outlet, ensure the 160/180mm hose clamp (item 22) is correctly orientated on the hose as shown in step 40, tighten the hose clamp.

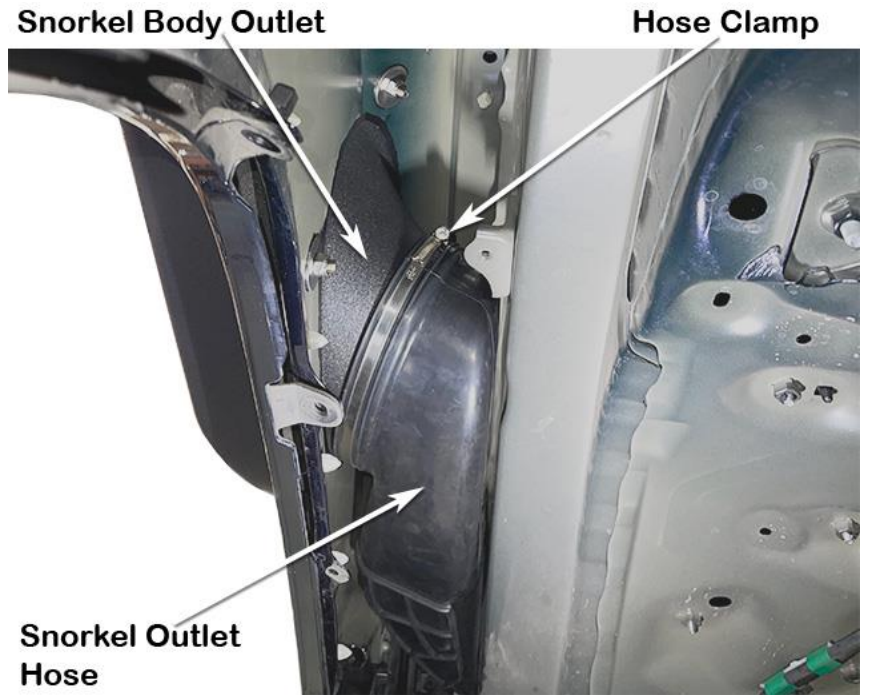

Install the Sonoflex ducting (item 29) into the air cleaner base and into the air cleaner entry hose, rotating the ducting whilst installing to ensure the ducting engages into the stainless steel joiner.

The sonoflex ducting should finish level with the 1st rib in the air cleaner base as shown.

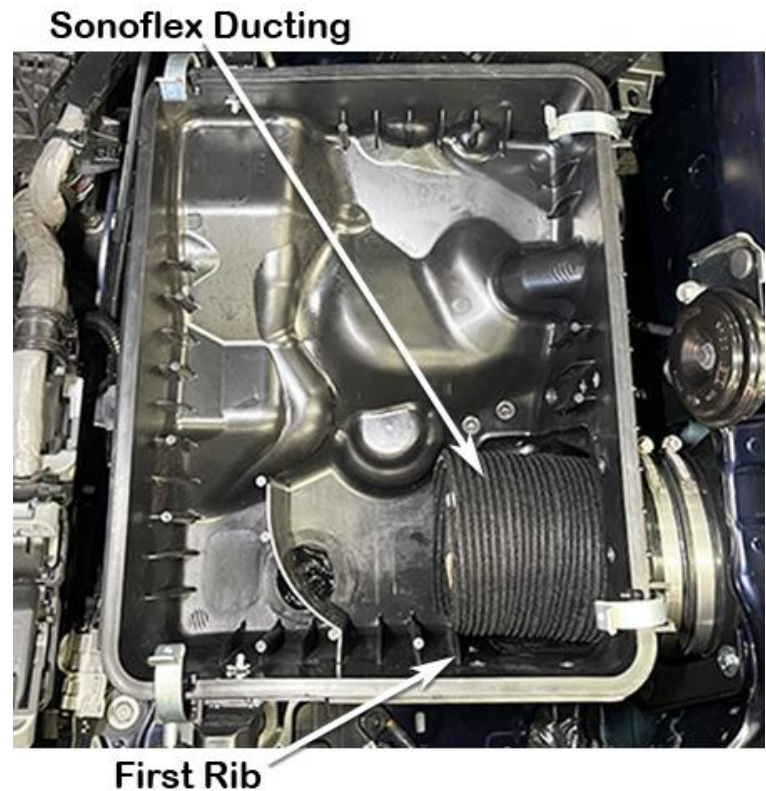

46

Install the ARMAX air ram assembly (item 2) onto the snorkel body.

Align the ARMAX air ram assembly mount holes with the four pre-drilled 2mm holes in snorkel body inlet.

Secure the ARMAX air ram (item 2) to the Snorkel Body (item 1) with four black self-tapping screws (item 28).



47

Install the top plastic guard panel trim and Inner guard plastic intake insulator, removed in step 2.

48

Install the inner guard liner, mud flap, horn, air filter element, air cleaner lid, reconnect sensor wiring and any other parts that may have been removed in accordance with the factory service manual.

49

N.B: It is the installer's responsibility to ensure that all connections are water tight.