

SS96HF

SAFARI V-SPEC SNORKEL
MERCEDES BENZ SPRINTER, 2006 Onwards
Right Hand Drive, (All Diesel Engines)



20/11/2013

Parts List

ITEM	PART NO.	DESCRIPTION	QTY
1	905-133-000	BODY - SNORKEL (SS95HF)	1
2	000-135-800	3.5" AIR RAM ASSEMBLY	1
3	905-032-000	BRACKET - UPPER MOUNTING	1
4	000-002-100	BOLT - HEX - 6mm x 1.0 x 14mm (SEMS)	2
5	000-954-100	RIVNUT - 4.0mm x 0.7 x 10.8mm	3
6	000-093-300	BOLT - B/H - 4.0 x 0.7 x 12.0mm - S/S	3
7	000-954-200	RIVNUT - 6.0mm x 1.0 x 14.5mm	2
8	000-347	WASHER - BODY - 9mm x 31.8mm - S/S	2
9	000-1038-300	BOLT - S/H - 6.0 x 1.0 x 35mm - S/S	2
10	000-353	WASHER - BODY - 6mm x 18mm - S/S	2
11	905-024-100	HOSE - SNORKEL OUTLET	1
12	485-025-000	JOINER - 90mm OD x 60mm LONG	1
13	905-024-300	HOSE - AIR CLEANER ENTRY	1
14	000-987-550	CABLE TIE - 8mm x 550mm	1
15	000-910	CLAMP - HOSE - 90/110mm	4
16	000-914/B	CLAMP - HOSE - SIZE 56 (BLACK)	1
17	905-017-000	TEMPLATE - GUARD PANEL	1

Installation Guide

Fitment to:

- Left Hand Side

Fitting Time:

- 180min

Special Tools:

- 6.1mm & 9.0mm Drill Bits
- 32mm & 102mm Hole Saws
- Rivnut Gun M4 & M6
- Masking Tape
- Touch-up Paint

Prior to commencing the installation, it is the installer's responsibility to verify that all components and particularly the template (Item 17) are correct.

1

Remove and discard the air intake duct from the air cleaner assembly.

Remove the LHS mudflap and wheel arch liners to ensure all metal filings and swarf from the installation process can be easily removed.



Using a 32mm hole saw, drill out the earth boss shown (if fitted to vehicle).

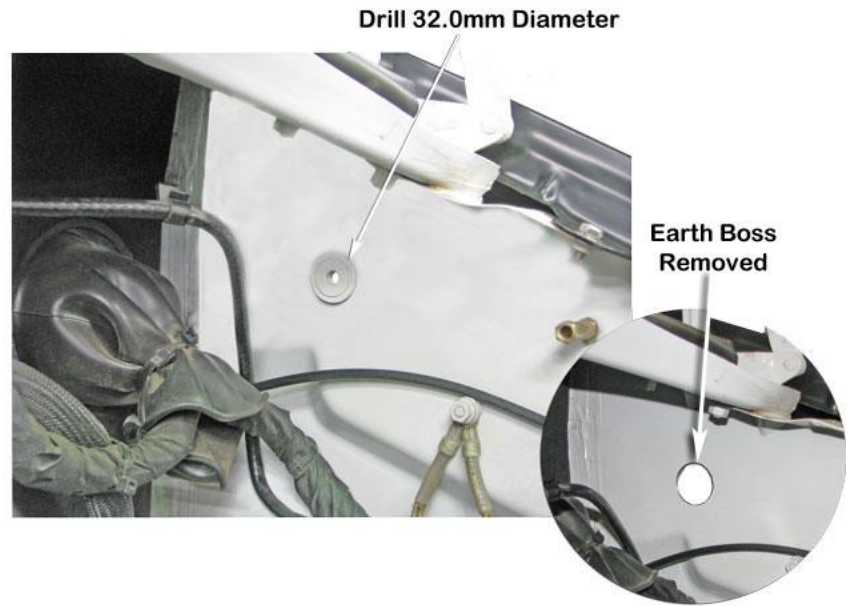

Align the guard panel template (item 17) to the upper and rear edges of the LHS guard panel. Tape the template to the guard panel with masking tape.

Mark all hole positions with a felt tip pen and remove the template.

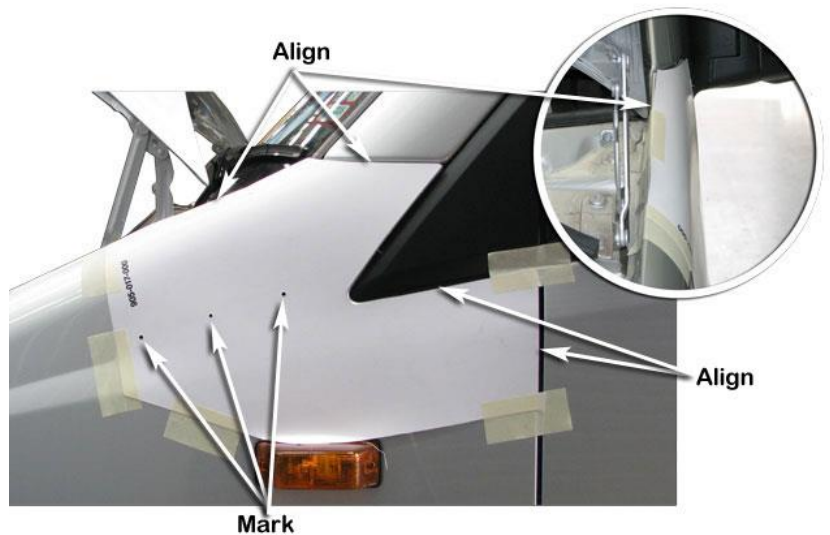

Drill a pilot hole for each of the marked hole positions.

Use a 102mm diameter hole saw to drill the snorkel body outlet hole position in the guard panel.

Use a 9.0mm drill bit to drill the two outer hole positions.

De-burr all holes.

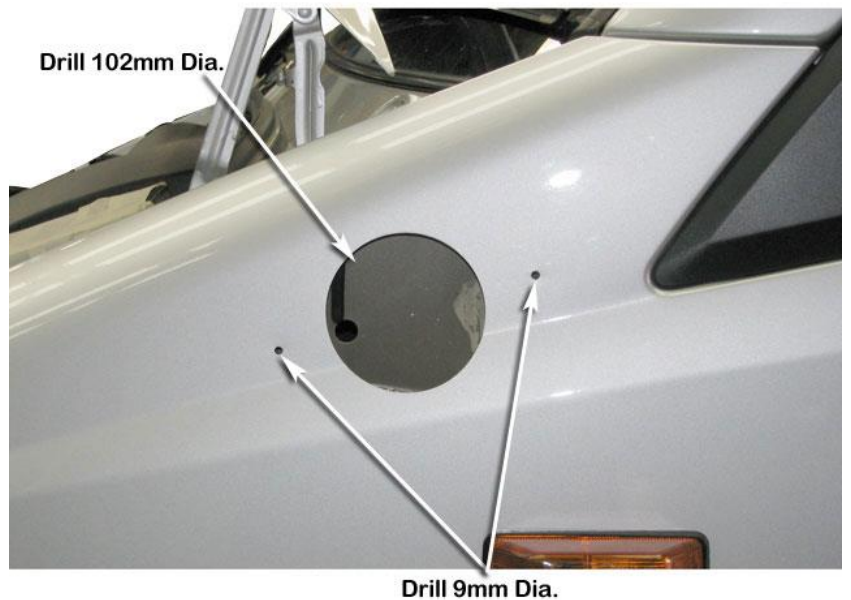

5

Using a centre punch, mark a point on the inner guard panel 5mm left of the centre of the 102mm hole along the axis that runs directly through the 9.0mm diameter holes.

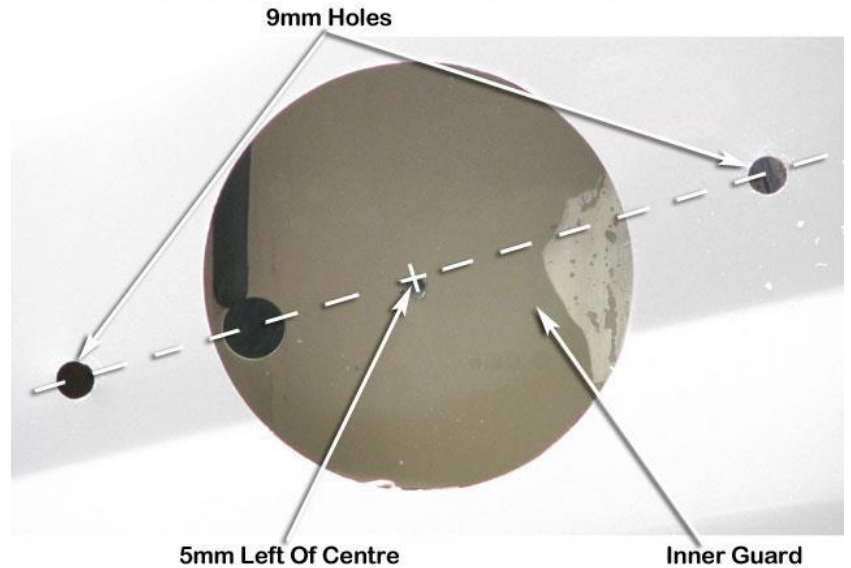

6

Drill a pilot hole at the marked hole position on the inner guard panel.

Drill the hole in the inner guard panel using the 102mm hole saw, making sure that the drill is perpendicular to the inner guard panel.

(extreme care must be taken whilst drilling to ensure the wiring harness is not damaged by the hole saw).



7

De-burr and paint all holes (earth boss, outer guard and inner guard panels) including the 9.0mm diameter holes.

Install the 6.0mm rivnuts (item 7) through the 9.0mm diameter holes in the guard panel, install a body washer (item 8) to the rear side of the guard panel over the rivnut, using the rivnut gun install the rivnuts and body washers to the guard panel as an assembly.

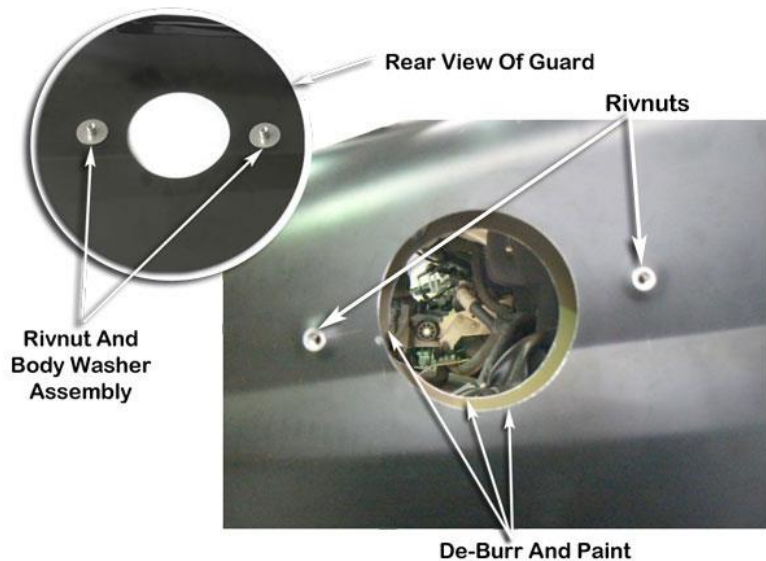

NEW ZEALAND INSTALLATIONS ONLY :

Safari have developed 2 methods of Snorkel A pillar attachment, for the conventional method please proceed with the current document alternatively please see the link below for further instructions.

www.safari4x4.co.nz/apillarmounting

8

Install the upper mounting bracket (item 3) to the snorkel body (item 1) with hex bolts (item 4).

Upper Mounting Bracket

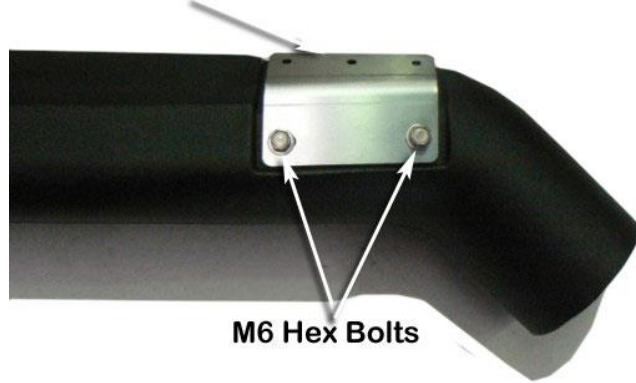

M6 Hex Bolts

9

Place a strip of masking tape along the A-Pillar panel.

Install the snorkel body (Item 1) to the guard panel with 6mm x 35mm socket-head bolts (Item 9) and 6mm x 18mm body washers (Item 10).



6mm Body Washers & M6 Socket Head Bolts

10

With the snorkel body correctly positioned, mark the outline of the upper mounting bracket (Item 3) onto the masking tape with a felt tip pen as shown.

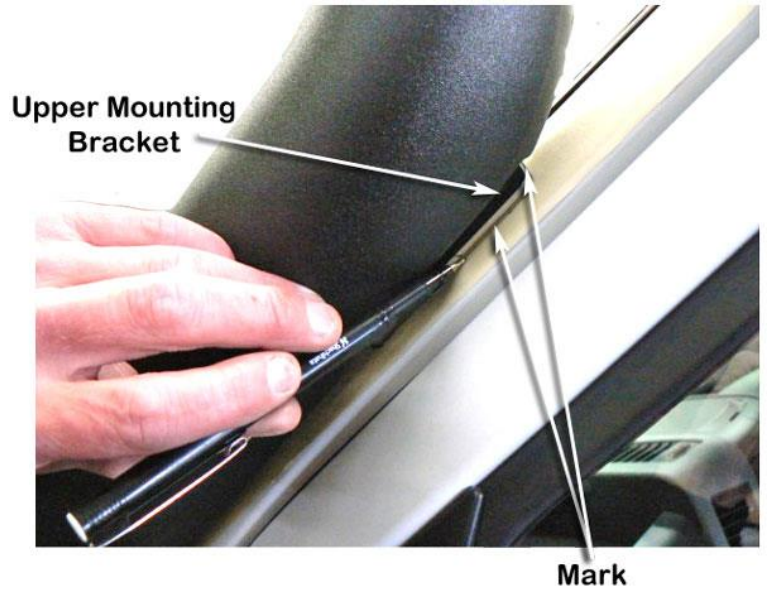

11

Remove the snorkel body (Item 1) from the vehicle and remove the upper mounting bracket (item 3) from the snorkel body.

Position the upper mounting bracket (item 3) onto the A-pillar and align the bracket with the marked bracket outline. Mark the three mounting hole positions onto the masking tape with a felt tip pen.



12

Drill a pilot hole at each of the three (3) marked hole positions. Drill each hole position to 6.1mm diameter.

Remove the masking tape from the A-Pillar. De-burr and paint holes.

Install the 4mm rivnuts (Item 5) into the 6.1mm holes in the A-Pillar using the rivnut gun.

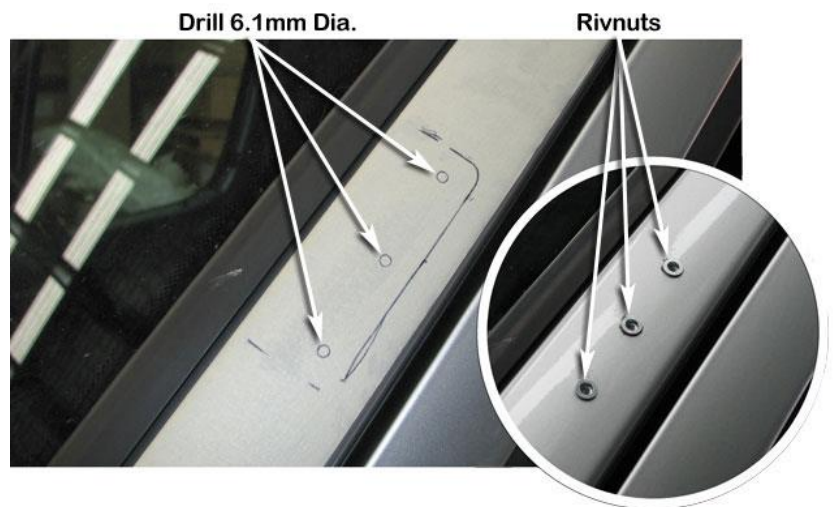

13

Secure the upper mounting bracket (item 3) to the A-Pillar with three 4mm x 12mm button head bolts (item 6).

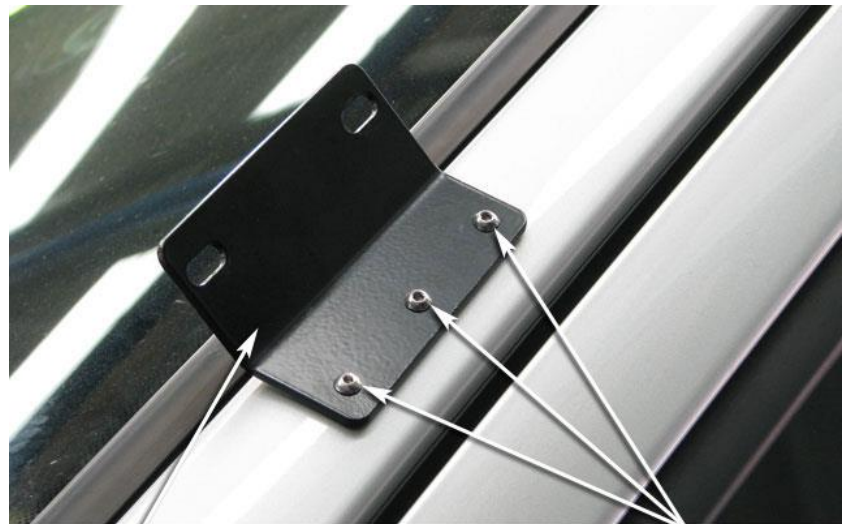

Upper Mounting Bracket

M4 Button Head Bolts

14

Carefully install the snorkel body (item 1) to the guard panel and align the snorkel body to the guard panel and upper mounting bracket.

When correctly aligned, fasten the snorkel body to guard panel with 6mm x 35mm socket head bolts (item 9) and 6mm x 18mm body washers (item 10).

Fasten the snorkel body to the upper mounting bracket with hex bolts (item 4).



6mm Body Washers & Socket Head Bolts

Upper Mounting Bracket

15

INSTALLER OPTION :

The air cleaner housing base has one small drain hole as shown. The drain hole can permit water to enter the air intake.

It is up to the installer to decide whether the drain hole should be sealed.

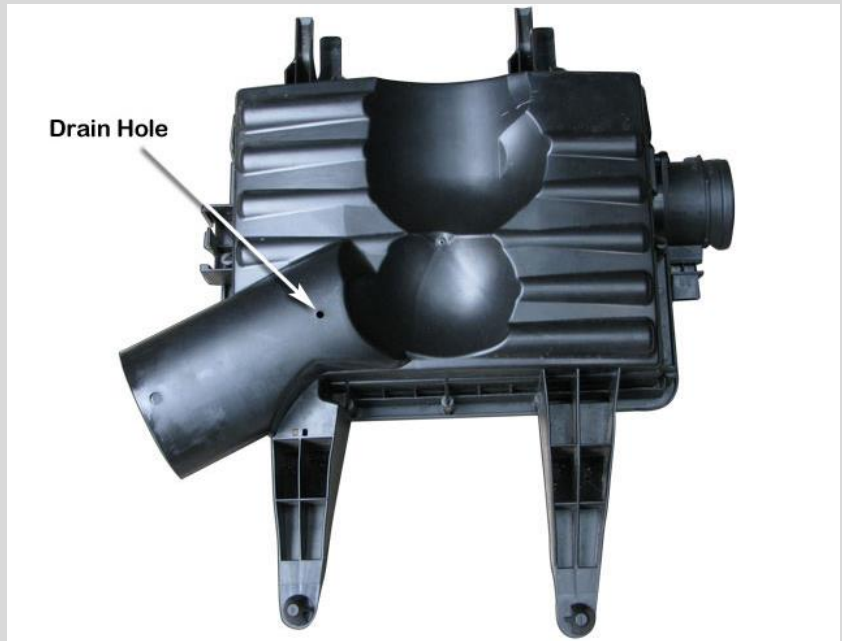

16

Mark a line around the circumference of the joiner (Item 12) 30mm in from the end with a felt tip pen.

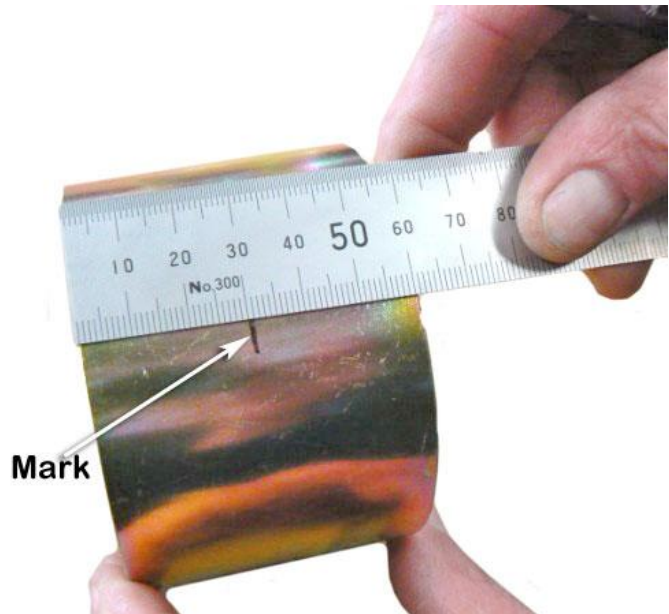

17

Install the joiner (Item 12) into the snorkel outlet hose (Item 11), and align the 30mm mark to the end of the hose. Secure the joiner in place with a 90/110mm hose clamp (Item 15).

Install a 90/110mm hose clamp (item 15) loosely to the other end of the snorkel outlet hose.



18

Install the snorkel outlet hose (item 11) to the snorkel body outlet snout protruding through the inner guard. Do not tighten the hose clamp yet.

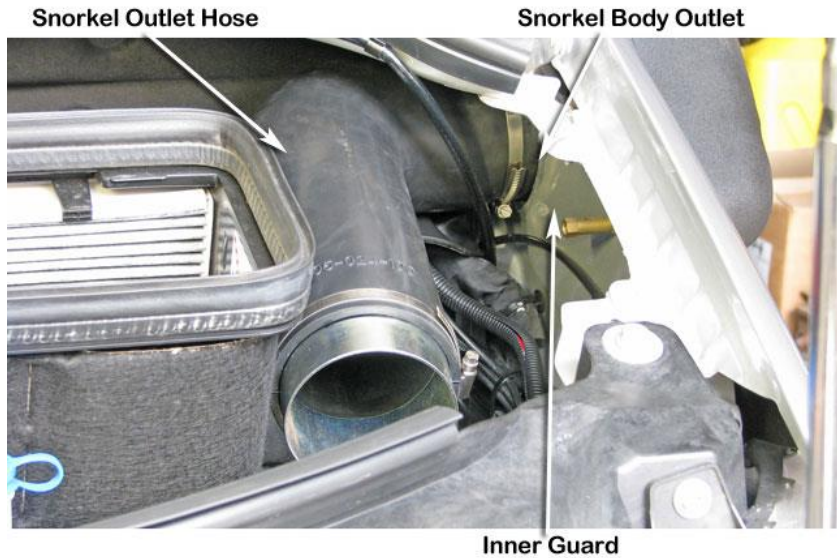

19

Install a 90/110mm hose clamp (Item 15) to either end of the air cleaner entry hose (Item 13), form one of the hose clamps to the oval shape of the air cleaner entry hose end.

Note: the orientation of the hose clamp at the oval end.

Install the round end of the air cleaner entry hose to the joiner (Item 12), and the oval end to the air cleaner assembly. Orientate both hoses to provide best fit and clearance. Tighten all hose clamps.

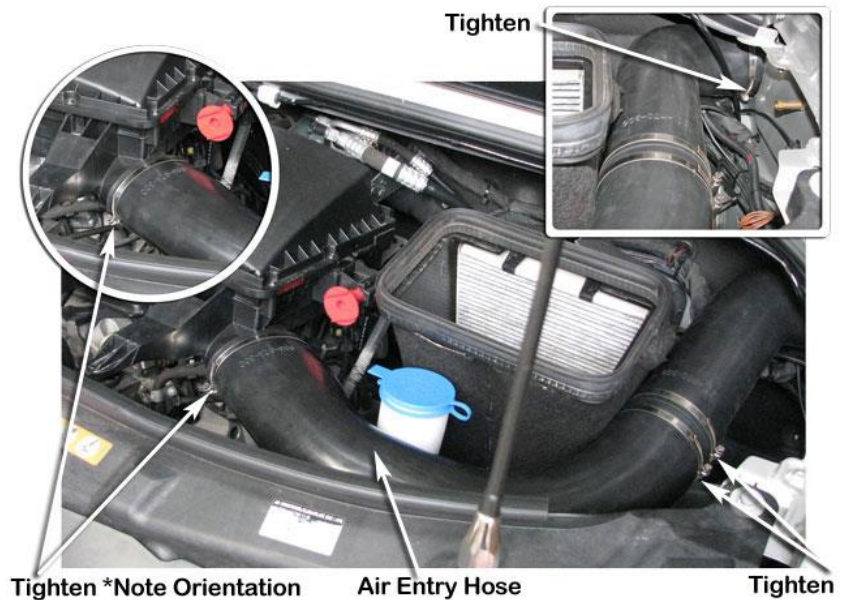

Measure and mark two hole positions 75mm and 175mm down from the top edge of the cabin air inlet housing seal as shown, ensure the hole positions are in the centre of the two hose clamps.

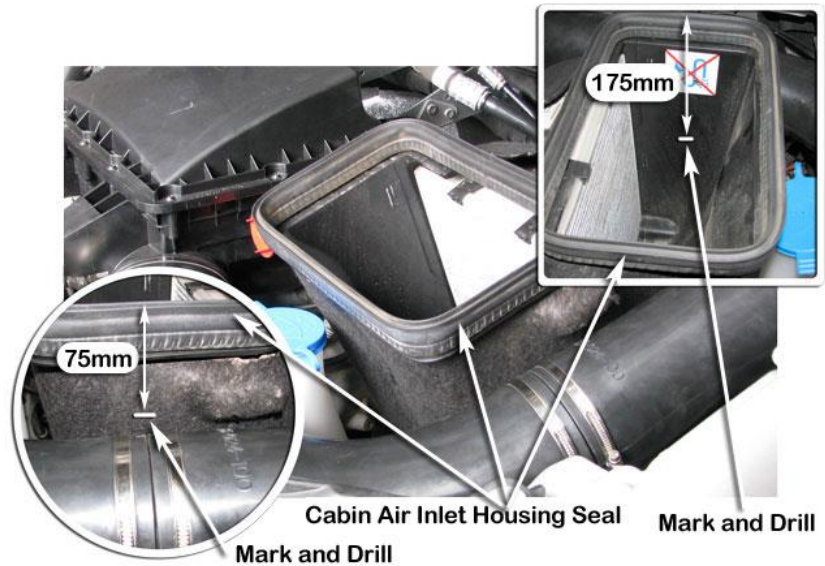

Drill two or three 2mm diameter holes at the marked positions making a slot 2mm x 10mm for the cable tie.

Install the cable tie (item 14) through the slots and around the hoses, tighten the cable tie to secure the hoses to the cabin air inlet housing.

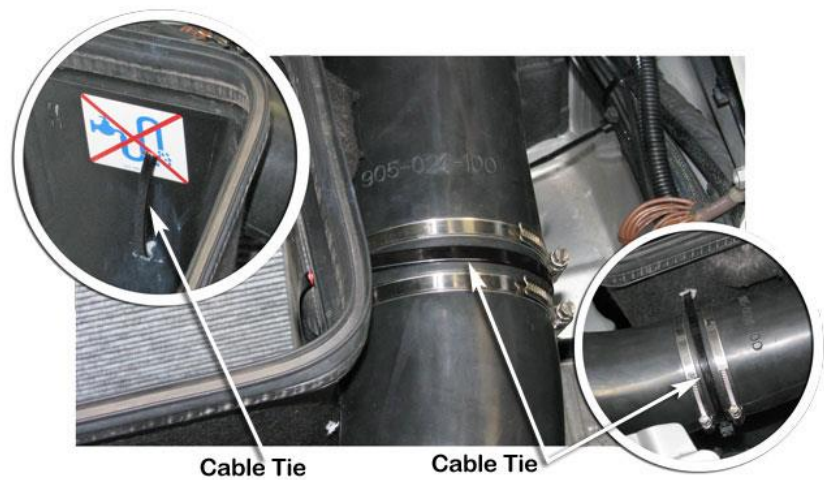

Install the Black hose clamp (Item 16) loosely over the base of the air ram assembly (Item 2). Install the air ram assembly onto the snorkel body.

Align the air ram assembly and tighten the black hose clamp (item 16).

Install the wheel arch inner liners and any other items that may have been removed during the snorkel installation process.

