



4X4 ENGINEERING

SMIVDJ200

**TOYOTA LANDCRUISER 200 SERIES 2007-2015
(EURO 4) ALL MODELS**

PATENT PENDING





WARNING!!

The Safari Armax Engine Control Unit (ECU) CANNOT be used in conjunction with any aftermarket electrical device, micro controller or altered/reflashed OE control unit which influences the operation of the OE control unit and/or the operation of the vehicles drivetrain, without specific written consent from Safari 4x4 Engineering Pty Ltd, failure to seek written consent will void all claims against vehicle drivetrain warranties which Safari 4x4 Engineering offer as part of this system.

Parts List

ITEM	PART NO	DESCRIPTION	QTY
1	000-081-700	SAFARI ARMAX ECU	1
2	370-283-000	WIRING HARNESS AM2P	1
3	370-283-150	WIRING HARNESS AM2P- IN CAR	1
4	000-716-200	MOUNT-DTM	1
5	000-082-000	SWITCH - 5 POSITION - ECU	1
6	000-088-100	EGT THERMOCOUPLE ASSY	1
7	370-289-000	MOUNTING BRACKET A	1
8	370-289-100	MOUNTING BRACKET B	1
9	000-001-500	BOLT - M6 X 12MM - SEMS - SS	2
10	000-001-600	BOLT - M6 X 15MM - SEMS - SS	2
11	000-003-400	BOLT - M6 X 20MM - SEMS - SS	2
12	000-987-290	CABLE TIE	20
13	000-987-100	CABLE TIE	2
14	000-717-500	BRIDGE OUT CONNECTOR-AM2P	1

Pre installation checklist:

- Check engine oil level
- Check fuel filter condition
- Check air filter condition
- Check for pre existing fault codes
- Check injector compensation values are within manufacturers specification.
- Check vehicle doesn't blow excessive smoke
- Check for other performance devices/controllers

Any faults must be rectified prior to the installation of the ARMAX ECU. Contact Safari 4x4 engineering for further information.

1

Remove air box lid, air filter and intake tube.

Remove



2

Remove intercooler shroud.

Remove two front mounting nuts and two rear mounting bolts.

Remove LH and RH intercooler outlet nuts.

Loosen LH and RH intercooler entry hose clamps.

Unplug air temperature and MAP sensor including vacuum hose, located between the two rear mounting bolts.

Carefully remove intercooler ensuring not to damage the fins

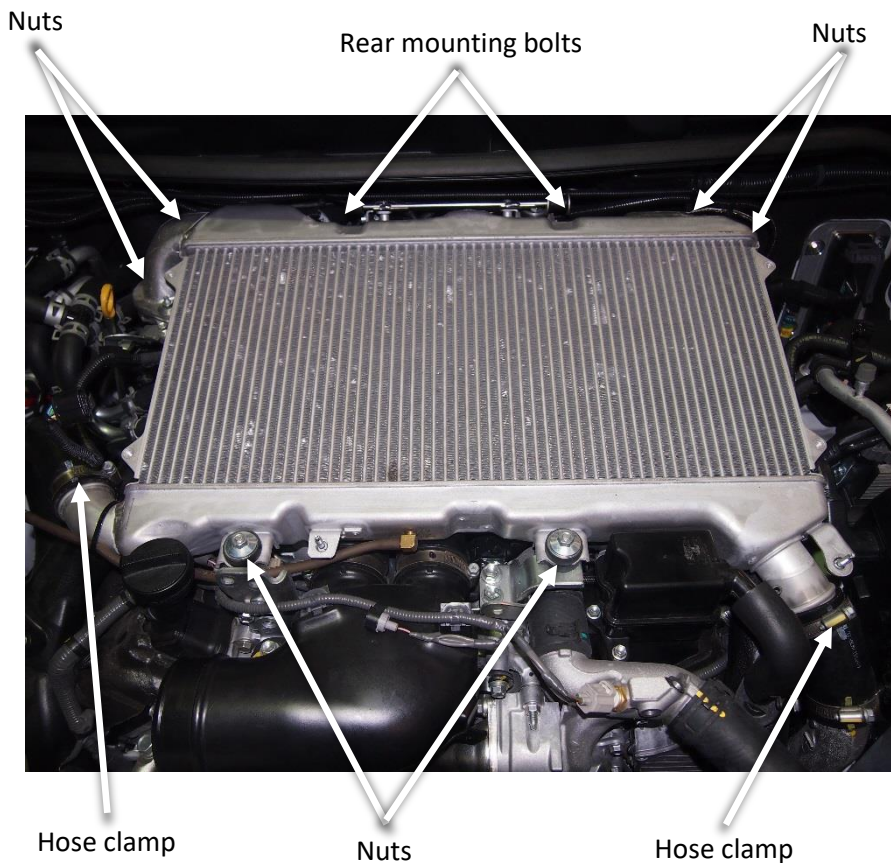

3

Trim the end off the grommet located on the firewall beside the brake master cylinder.

Locate the branch labelled IN CAR LOOM on the Armax wiring harness.

Feed the IN CAR LOOM through grommet in the firewall and pull through approximately 150mm into the driver's side foot well.

HINT: Use silicone spray on the end of the loom to help lubricate it through the firewall



4

Lay the remainder of the loom across the back of the engine along the firewall.

Install ECU mounting bracket A to the inner guard next to the master cylinder.

Use 2 x M6 x 20mm bolts to secure the mounting bracket.



Mounting bracket A

M6x20mm bolts

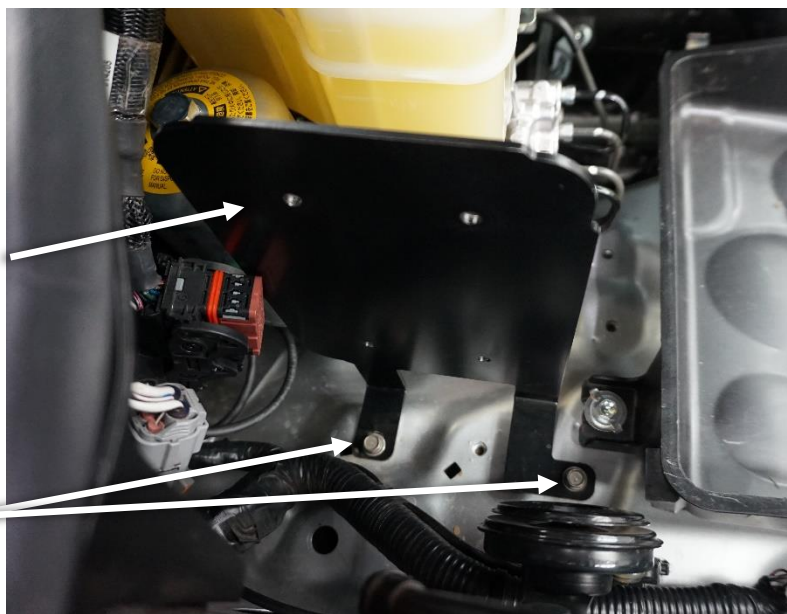

Remove OE brake pipe bracket bolt and retain.



Remove

Install ECU mounting bracket B to the master cylinder using the retained OE brake pipe bracket bolt but do not fully tighten.

Mounting bracket B



Connect the loom to the Armax ECU.

Connect the larger 48 pin connector first as shown then connect the smaller 32 pin connector in the same manner.

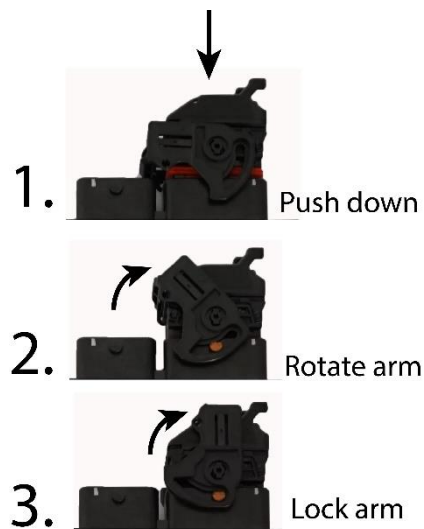

Bolt the ECU to the bracketry. Use 2 x M6 x 15mm bolts and 2 x M6 x 12mm where shown.

Fully tighten the OE brake pipe bracket bolt on the master cylinder.

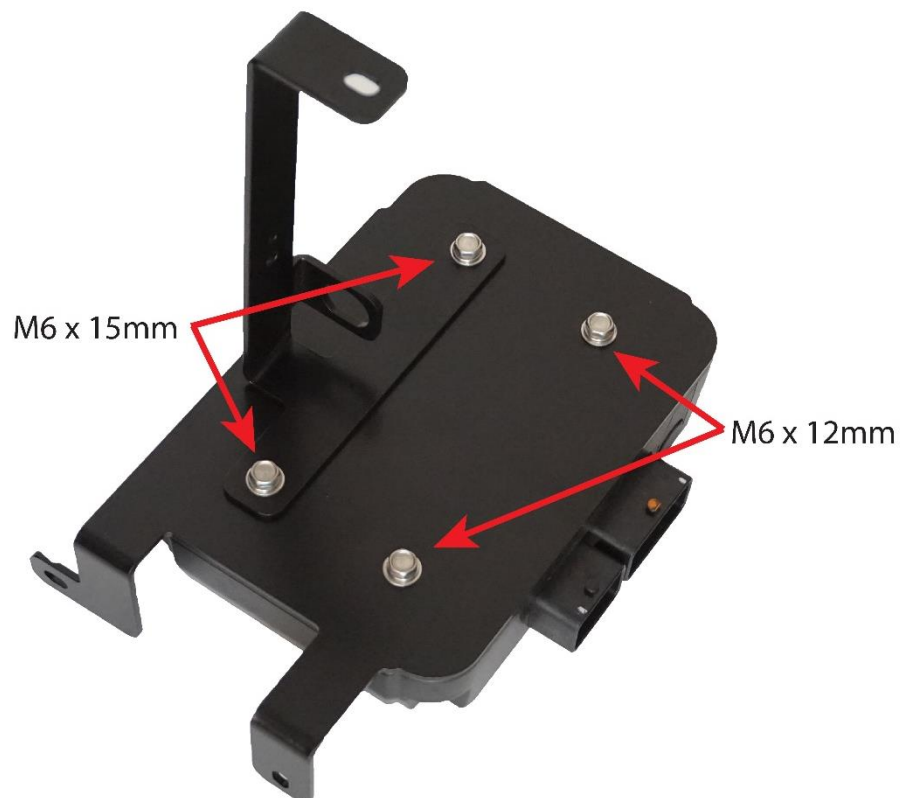
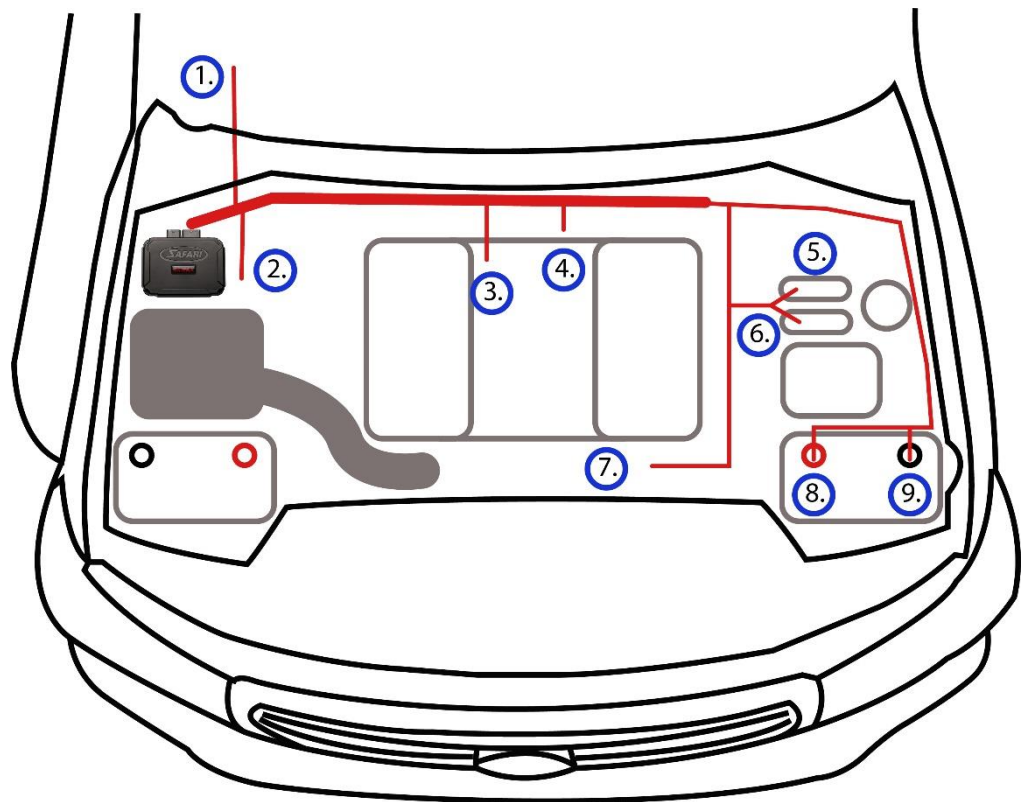

Diagram 1

Red: Armax wiring harness

1. In car loom
2. Exhaust gas temperature/co mmunications
3. RH fuel pressure sensor
4. MAP sensor
5. EDU 1
6. EDU 2
7. Crank angle sensor
8. Battery positive
9. Battery negative



Attach mounting clip to EGT connector.

Connect the mounting clip and connector to ECU mounting bracket B.

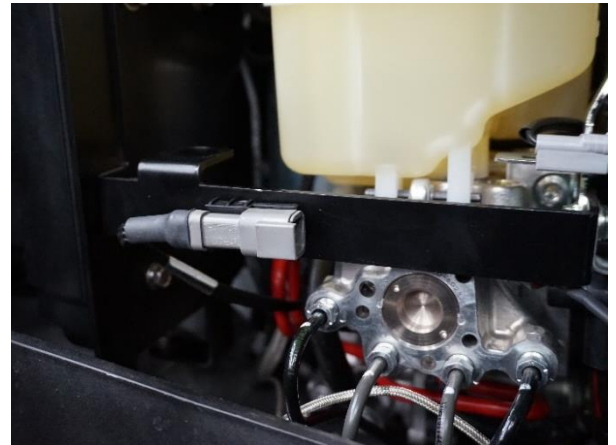
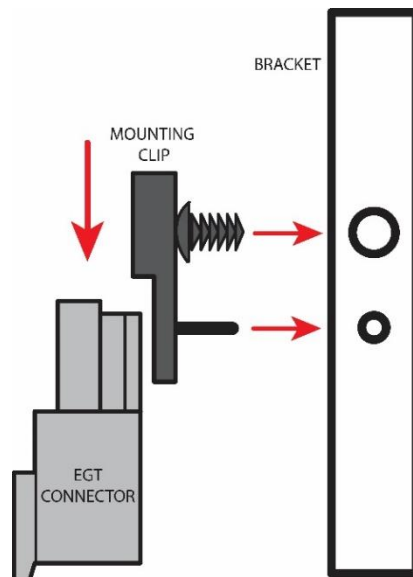

Mount the communications port to mounting bracket B.

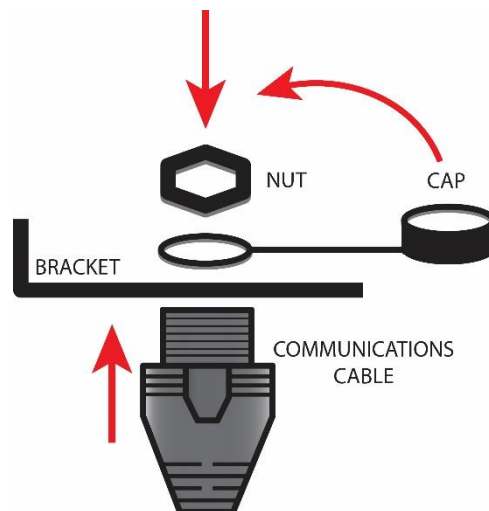

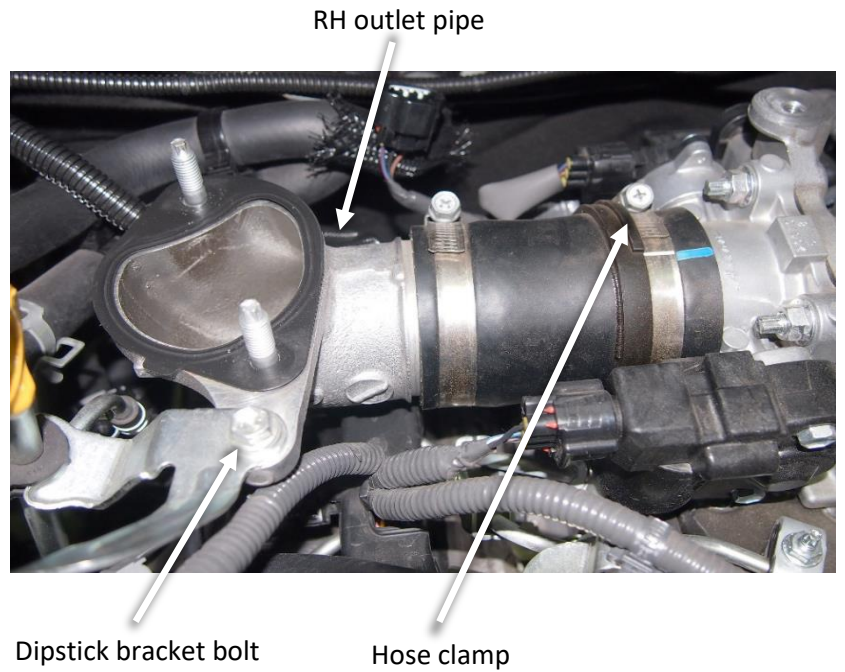

Remove RH intercooler outlet pipe.

Loosen hose clamp shown.

Remove dipstick bracket bolt.

Connect the Armax loom to fuel pressure sensor on RH fuel rail

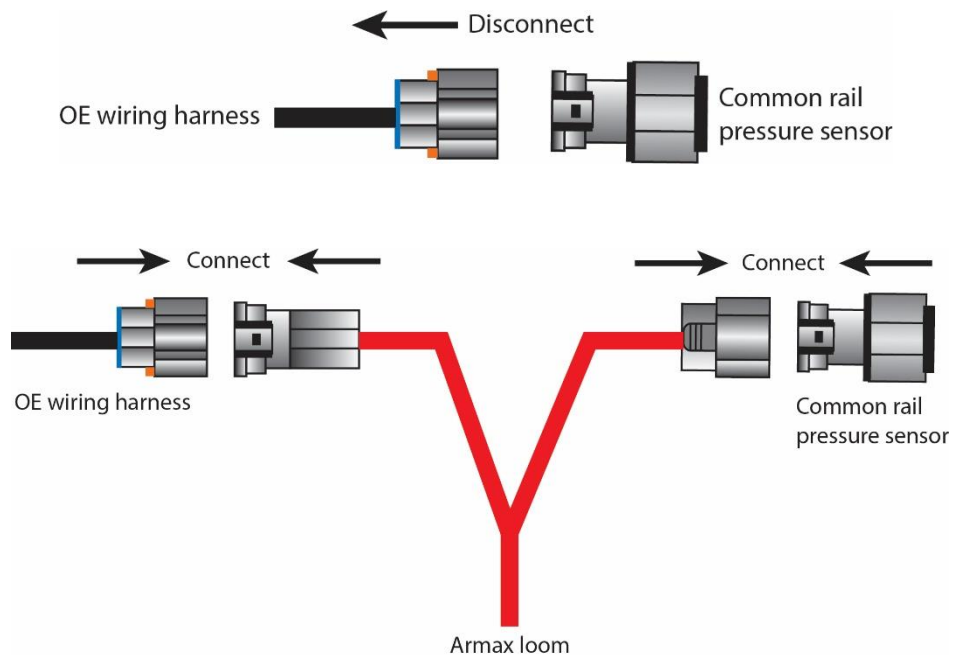
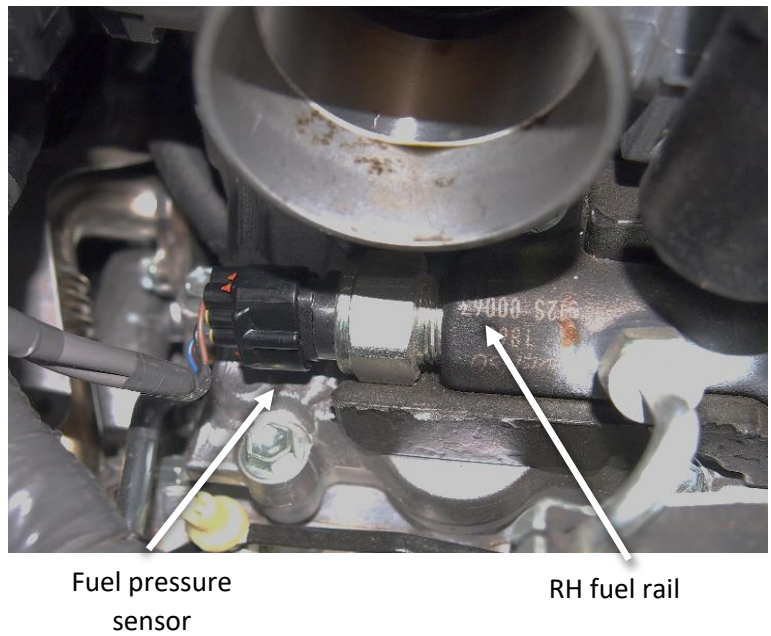

Use supplied cable ties to secure the ARMAX loom to the brake line that runs beneath the OE loom on the firewall.

Run the EDU branch down towards the front of the vehicle alongside the LH cylinder head.

Use supplied cable ties to secure the EDU branch to the OE loom running to the EDU's.

NOTE: ARMAX loom highlighted in red.

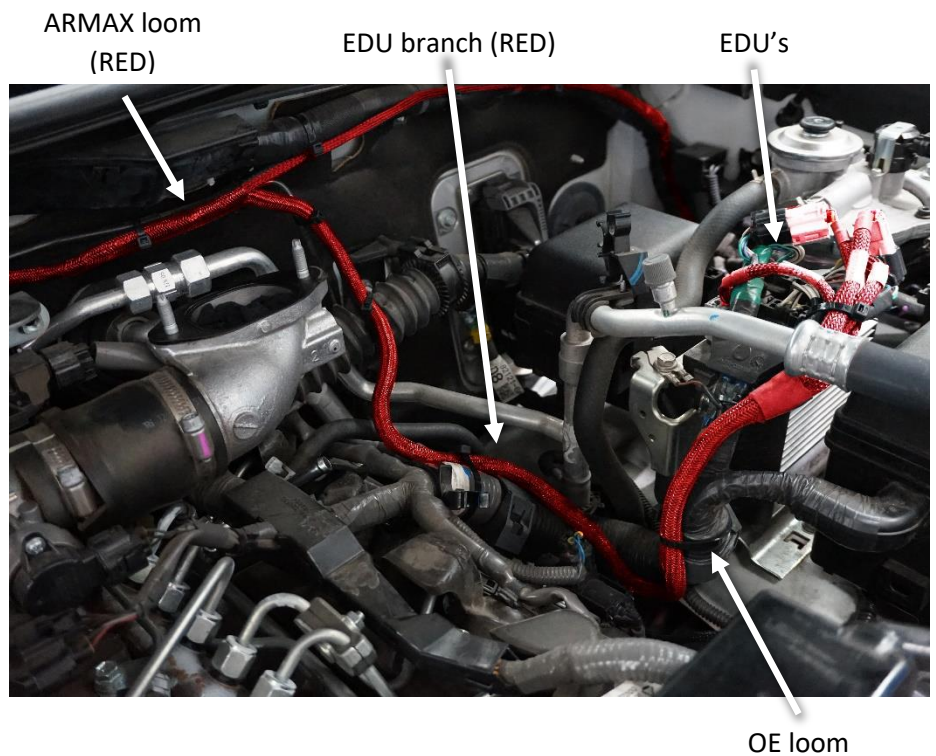
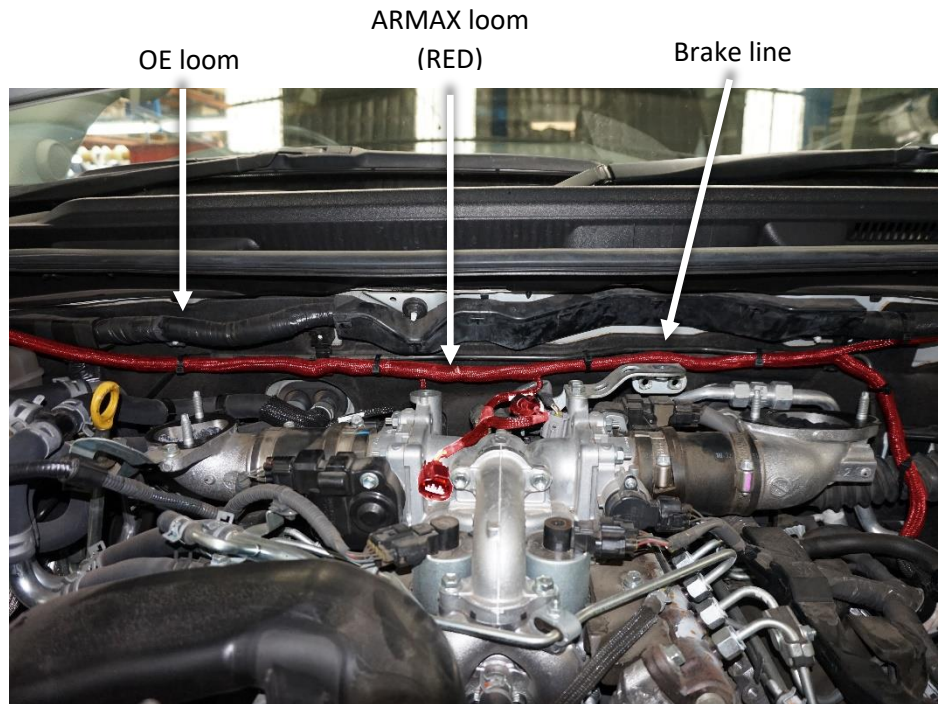

Connect the loom to EDU's

EDU 1 is closest to the firewall and has green tape on the OE loom. The Armax loom connects to the grey 8 pin plug on each EDU indicated in the photo.

NOTE: EDU location may vary with the fitment of aftermarket accessories such as a third battery. If you are unsure about identifying them correctly please contact Safari 4x4 for further information



WARNING!

DO NOT CROSS EDU CONNECTORS AS THIS MAY CAUSE ENGINE DAMAGE. PLEASE REFER TO THE PHOTOS AND DIAGRAMS BELOW TO IDENTIFY THE EDU'S. PLEASE CONTACT SAFARI 4X4 FOR FURTHER INFORMATION.

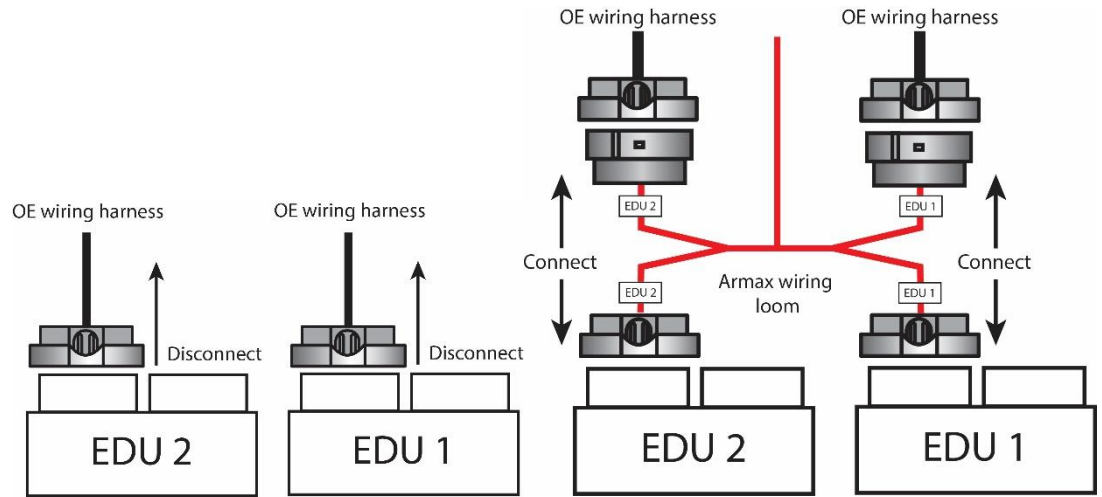
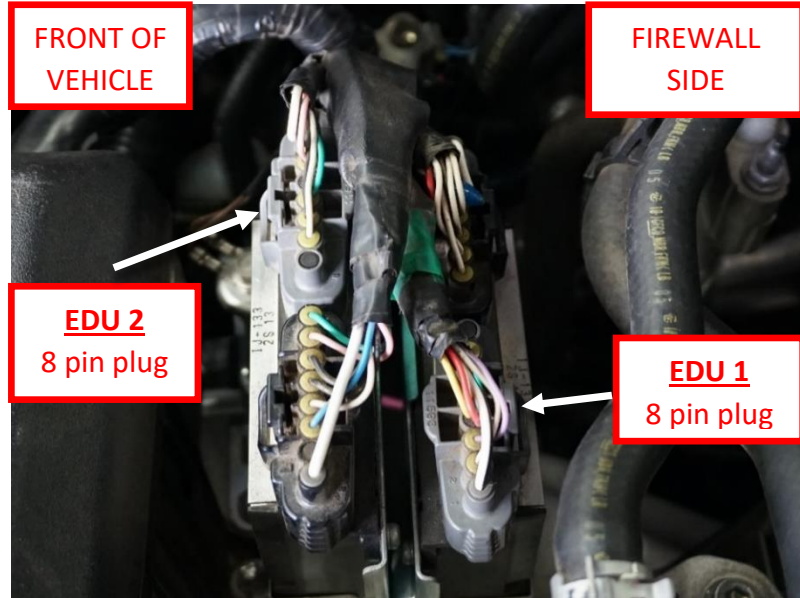

16 Route the battery loom branch along the firewall then along the inner guard towards the LH front battery. Connect the loom to the battery terminals. (Refer to diagram 1 on page 7)

Secure to the OE loom using supplied cable ties.

The battery loom **must** be connected to the battery positive and negative. Do not connect to an auxiliary battery or a body earth.

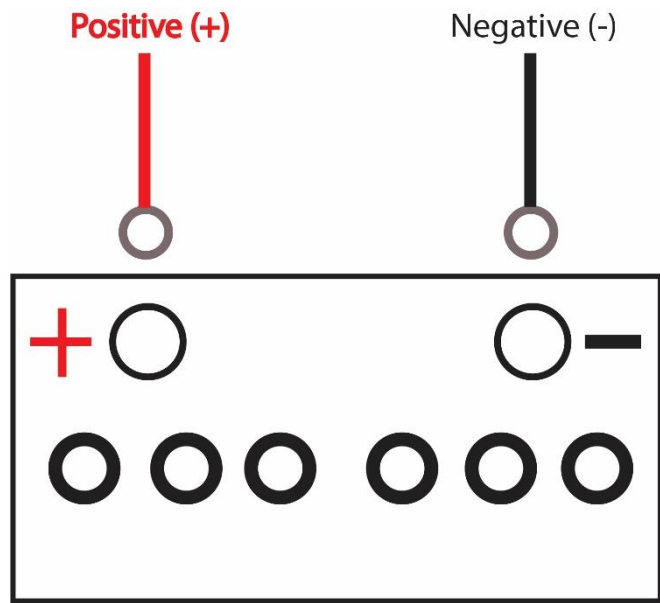

17

Remove LH under tray labelled "C".

Remove

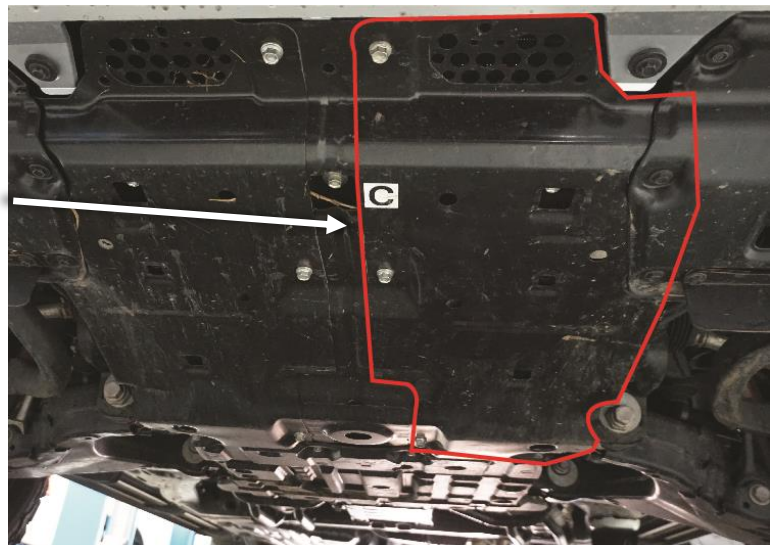

18

Route the crank angle sensor loom along the factory loom down to the crank angle sensor.

The crank angle sensor connector is located beneath the air conditioning compressor

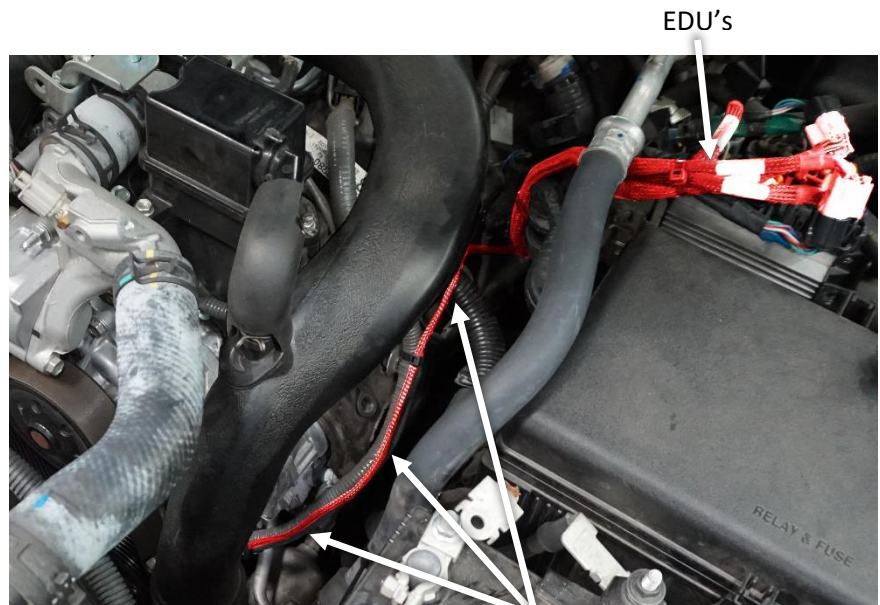

Crank angle sensor loom (Red)

Route the crank angle sensor wire along the factory loom down to the crank angle sensor.

Connect the Armax loom to the crank angle sensor connector.

Secure the crank angle sensor loom to the factory harness with supplied cable ties.

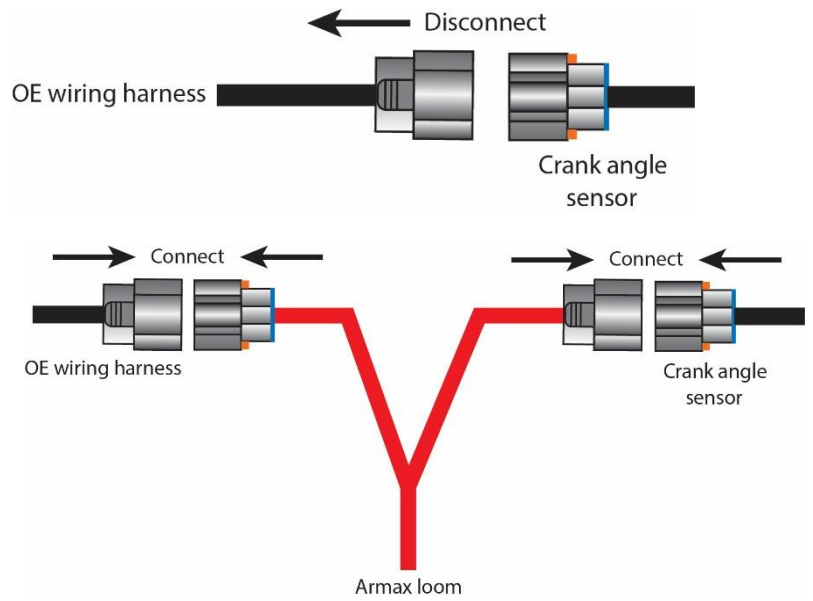

Refit the under tray

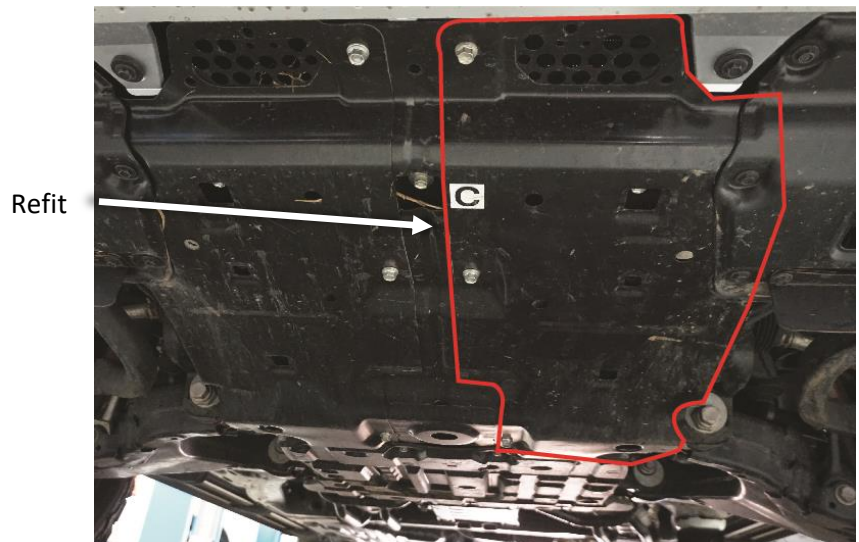

Reinstall the RH outlet pipe.

Reinstall the intercooler.

Use the supplied cable ties to secure the map sensor hose to the map sensor and the filter.

Do not fit the intercooler shroud

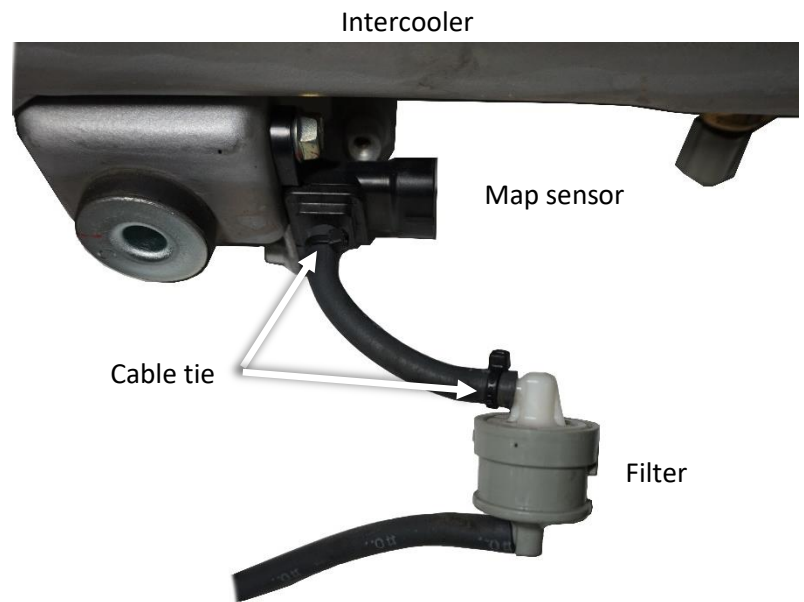

Connect the Armax loom to the MAP sensor.

The MAP sensor is located on the back of the intercooler.

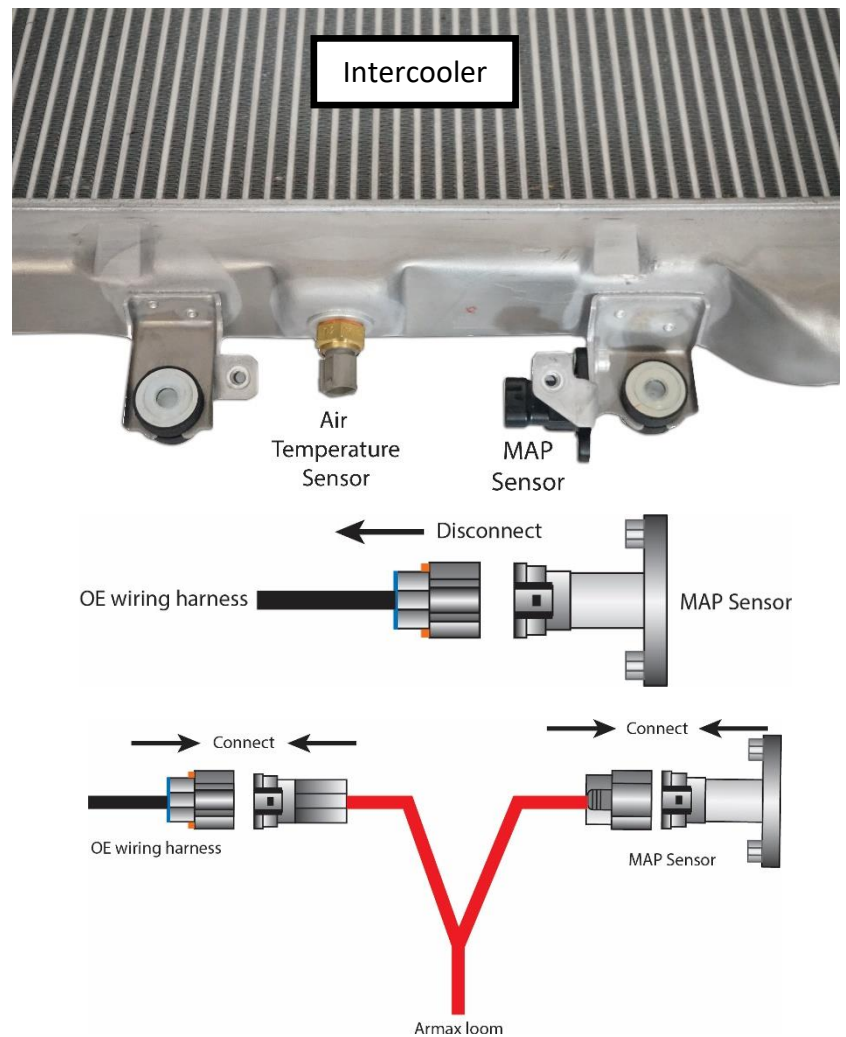

Refit the intercooler
shroud



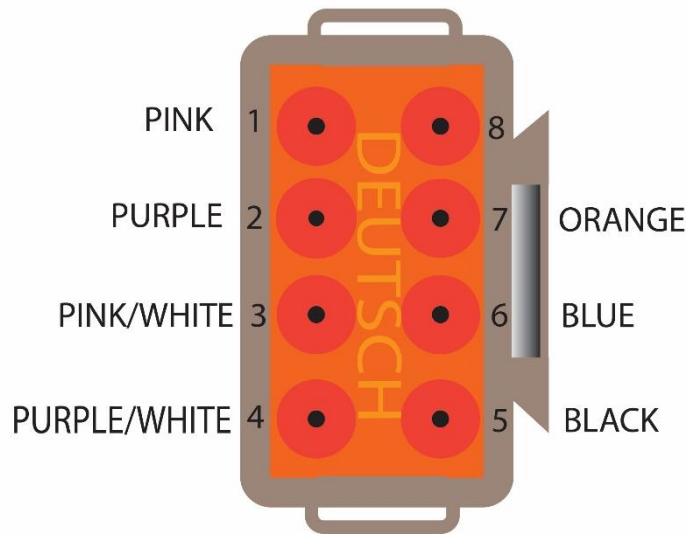

Locate the main harness in the driver's side footwell labelled IN CAR LOOM.

Use the diagrams to insert the terminals on the main harness into the DTM connector.

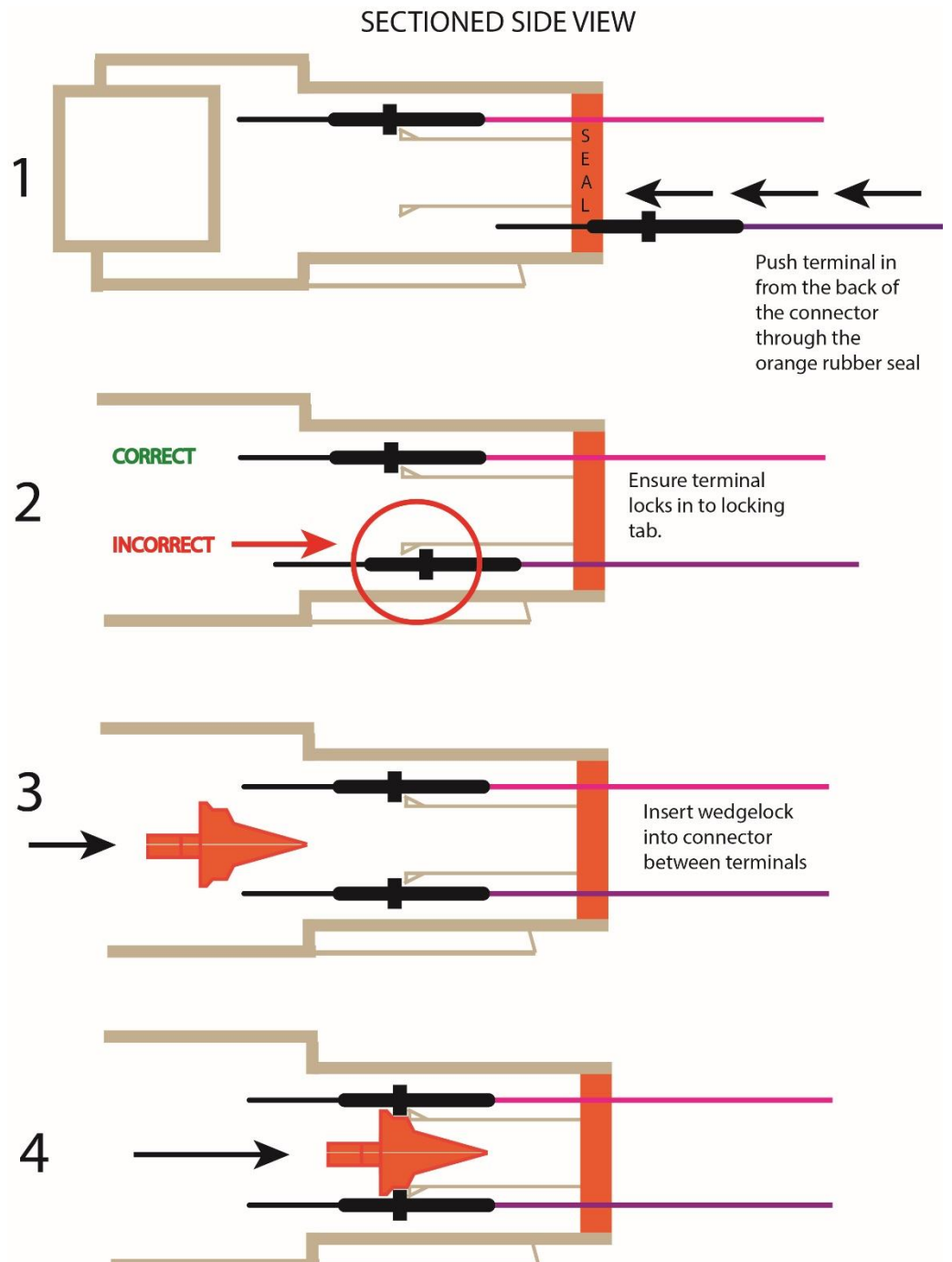

25

Connect the IN CAR LOOM (secondary harness) to the DTM connector on the main harness.

Check that the wire colours all correspond with each other.

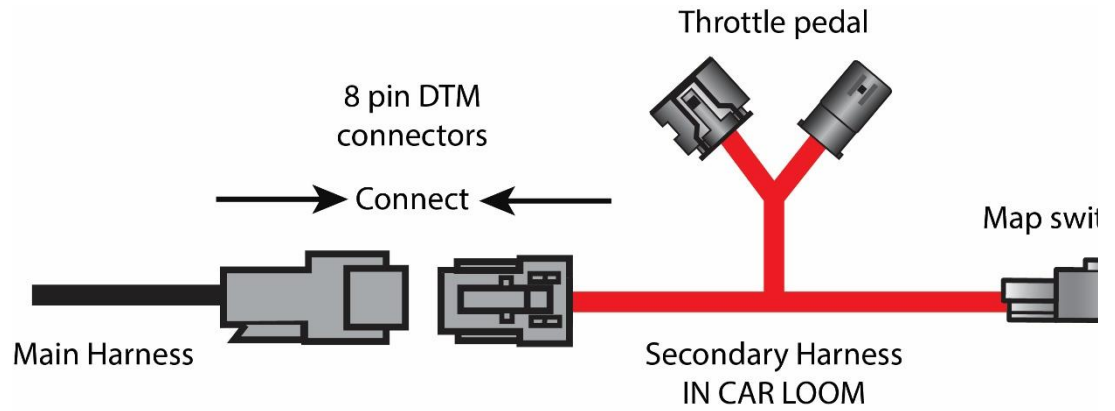

26

Connect the IN CAR LOOM to the throttle pedal sensor connector.

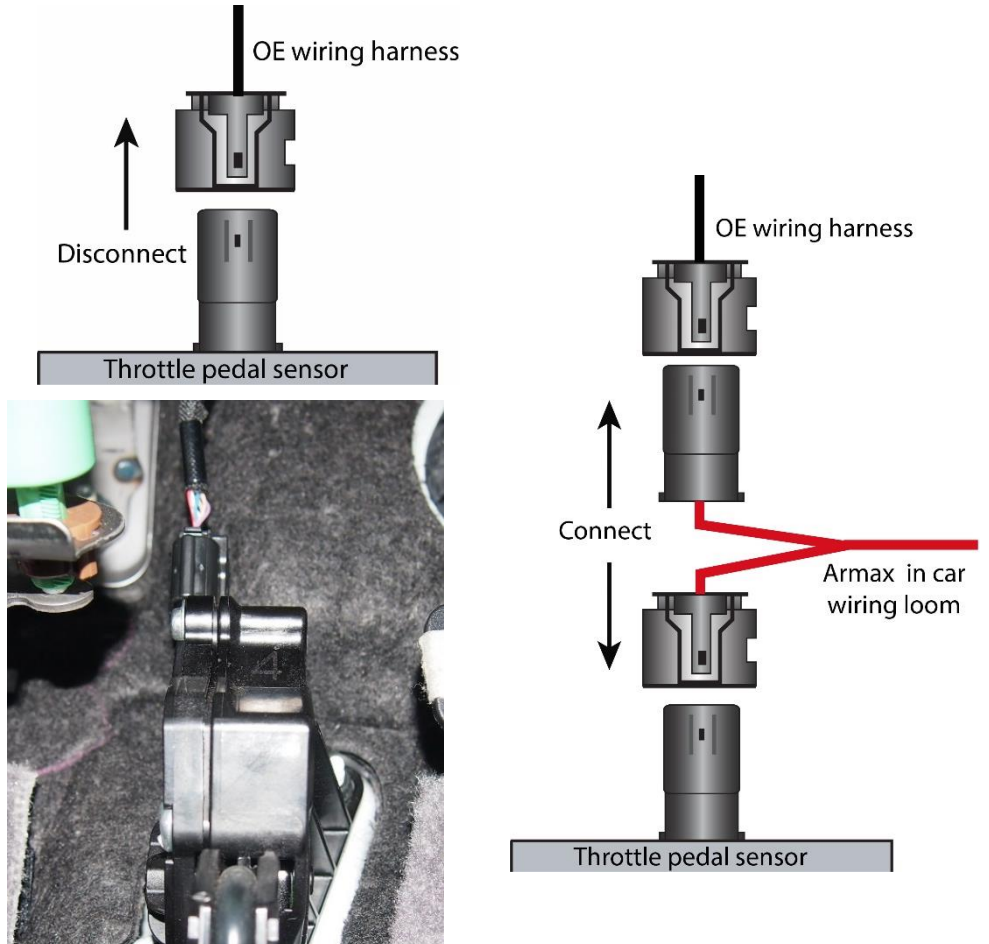

27

Remove the adhesive backing cover from the map select switch and mount in a position that the driver is comfortable with.

Ensure that it is on a flat clean surface to allow for maximum adhesion.

Remove adhesive backing cover

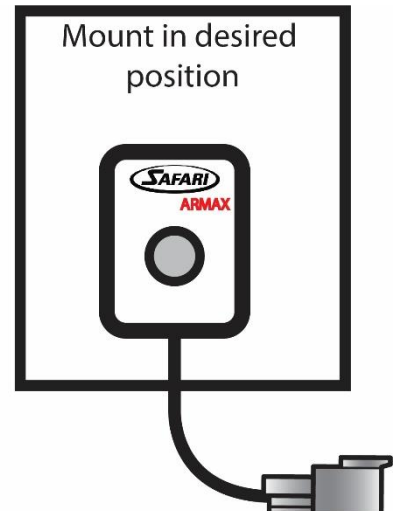

Connect switch to the IN CAR LOOM.

Neatly cable tie the IN CAR LOOM and any excess wire from the switch neatly in driver side foot well ensuring that it will not interfere with the drivers feet.

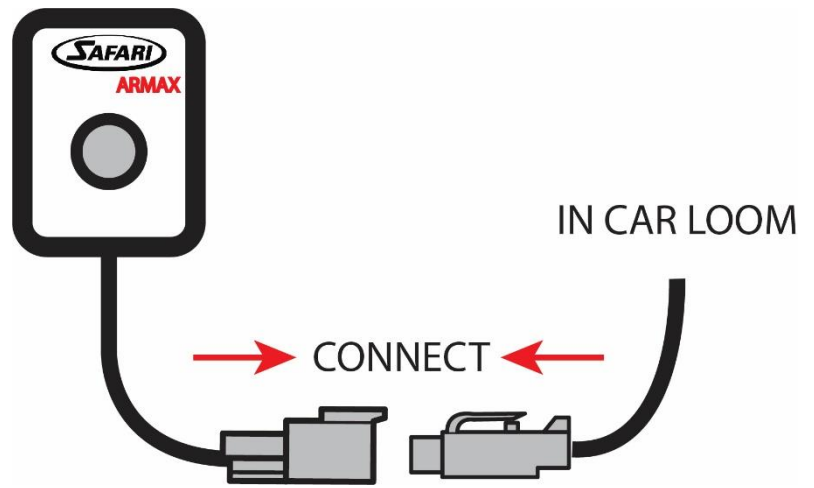

EGT thermocouple and clamp assembly

Install the EGT thermocouple into the clamp assembly.

Using a ruler measure the distance between the top of the EGT thermocouple and the clamp.

Set the distance according to diameter of the engine pipe at the back of the turbo (see diagram 2).

Once in position tighten the nut onto the clamp. When the nut is fully tightened the ferrule will lock the thermocouple into position.

Remove the thermocouple from the clamp.

IMPORTANT NOTE: The EGT depth is critical to the performance of the ECU. Ensure the depth is set correctly.

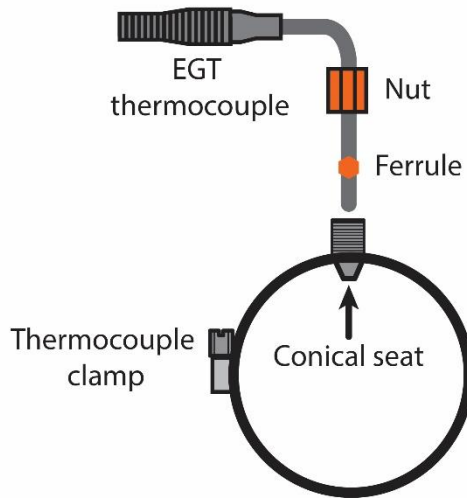

Standard engine pipe

3 inch engine pipe

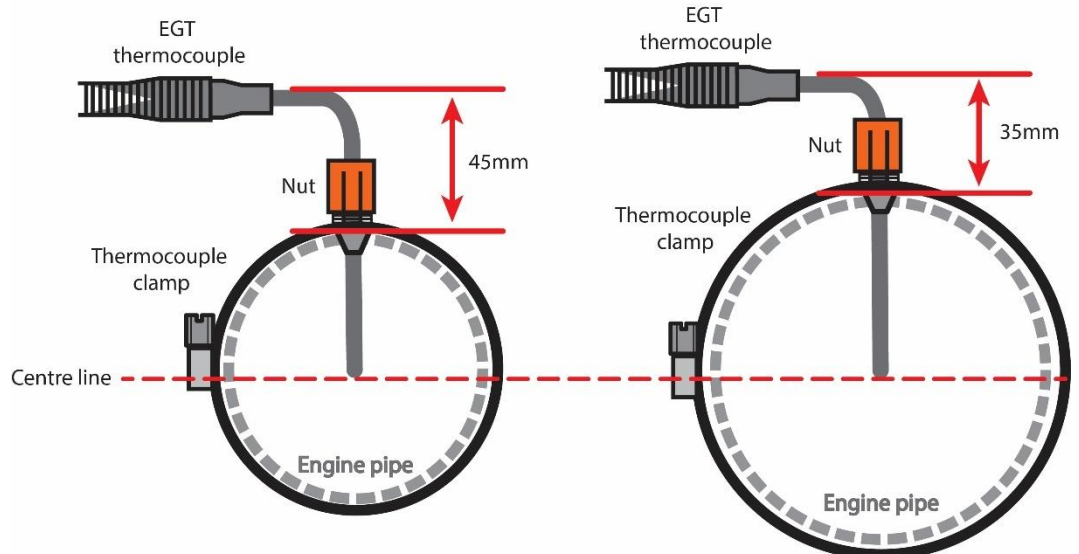

30

Remove the plastic inner guard cover from RHF wheel arch.

Remove

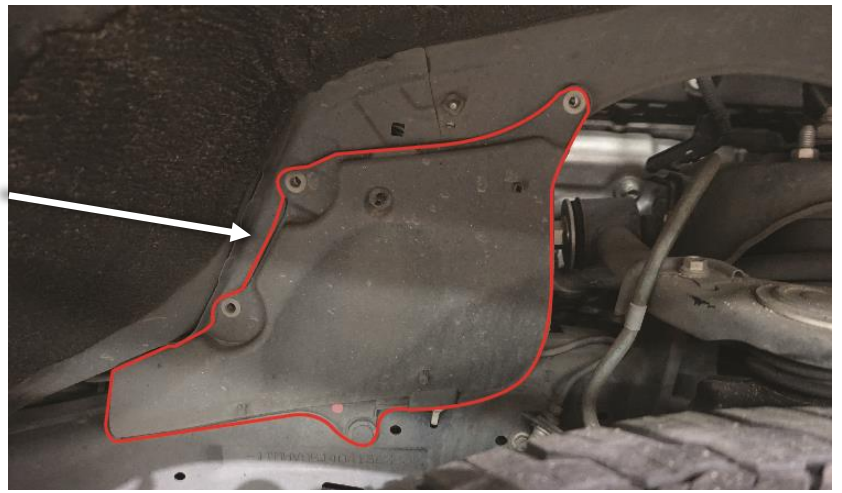

31

Mark location on RH engine pipe to be drilled for EGT thermocouple. Ensure that the thermocouple and clamp assembly will clear the exhaust manifold studs.

Centre punch and drill a 7mm hole where marked in RH engine pipe.

Mark and drill

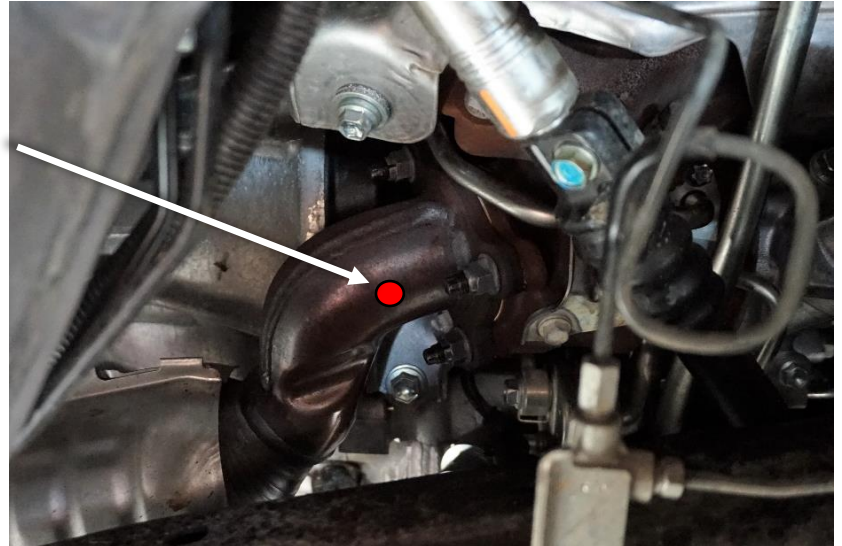

32

Install thermocouple clamp to engine pipe and tighten. Ensure the conical seat is aligned with 7mm hole

Cut off excess band from thermocouple clamp once tight. Use a file to remove sharp edges.

Cut off excess

Thermocouple clamp

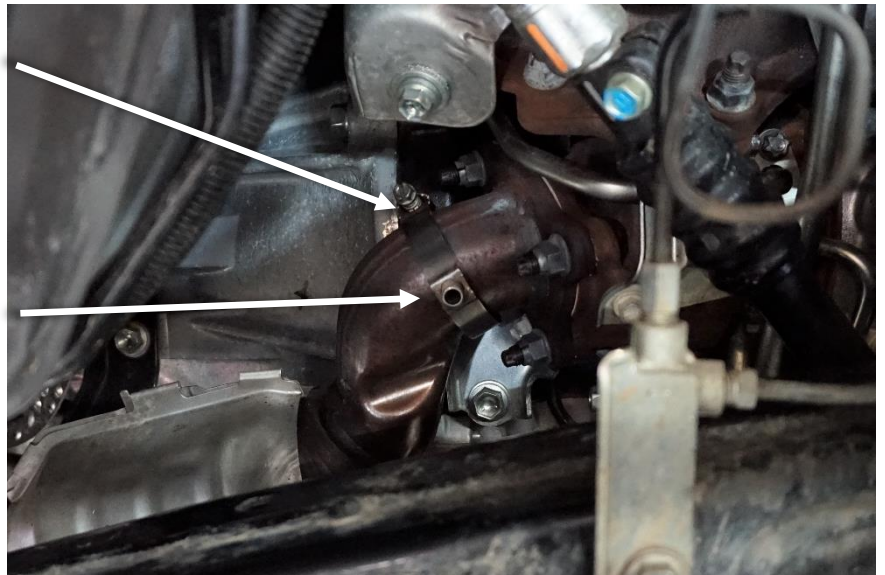

Install the EGT thermocouple into the clamp noting orientation shown and tighten.

EGT thermocouple

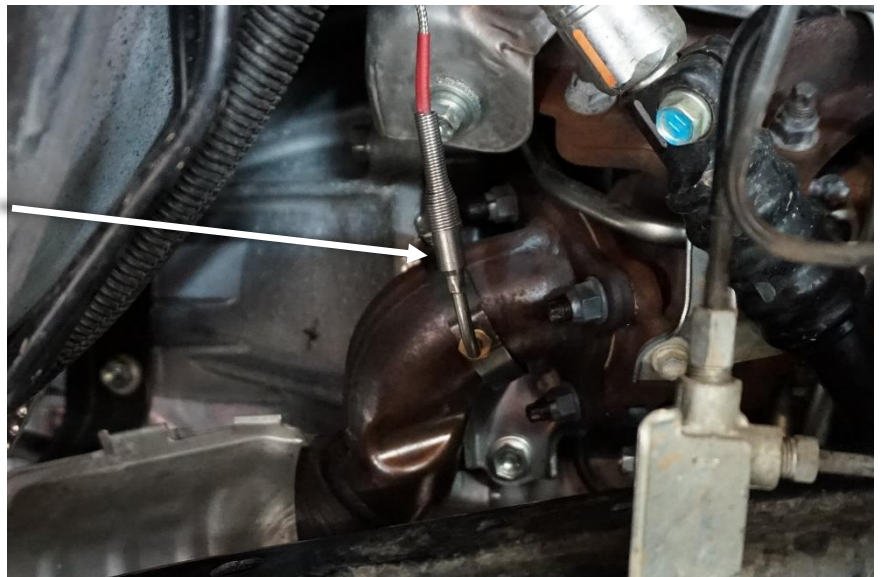

Route EGT wire vertically up firewall then following brake line routing back to the EGT connector mounted on the ECU mounting bracket. Plug EGT wire into the connector.

Coil up and neatly cable tie any excess length of EGT wire using supplied cable ties

EGT connector

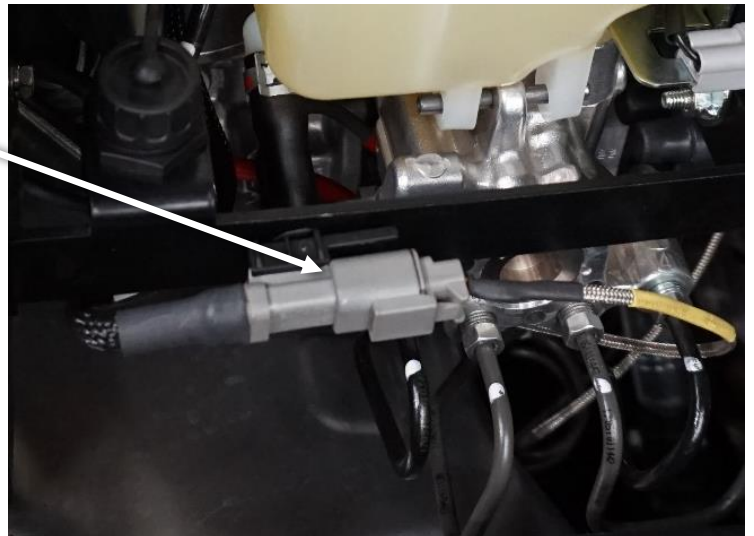

35 Final fitment checklist:

- Check all ECU mounting hardware is tight.
- Check the loom is secure and not in contact with the engine or exhaust.
- Check all connections are correct.
- Check EGT is connected and the thermocouple depth is correct.
- Check the Armax ECU diagnostics.
- **Place the user manual and bridge out connector in the glove box of the vehicle.**

Test drive checklist:

- Start vehicle and ensure there are no engine/warning lights.
- Check that the engine is operating as normal (not missfiring/making unusual sounds).
- Check that the switch illuminates and cycles through the different maps
- Drive the vehicle ensuring it reaches **full operating temperature** (the ECU will not operate at its full potential until this is reached). Drive the vehicle on different maps and check that the ECU operates correctly.