

SS665HF SAFARI V-SPEC SNORKEL

Mitsubishi Challenger PB series
2.5L DI-D Common Rail (4D56 Engine)



01/03/2011

Parts List

ITEM	PART NO.	DESCRIPTION	QTY
1	525-133-200	BODY - SNORKEL (SS665HF)	1
2	000-135-800	3 1/2" AIR RAM ASSEMBLY	1
3	525-032-000	BRACKET - UPPER MOUNTING	1
4	000-002-100	BOLT - HEX - 6mm x 1.0 x 14mm (SEMS)	3
5	000-951	SCREW - S/T - 4.2mm x 13mm - S/S	3
6	000-960	INSERT - PLASTIC	3
7	000-110	STUD - 8mm x 1.25 x 25mm - S/S	8
9	000-311-300	WASHER - BODY - 8mm x 30mm - S/S	8
10	000-205-300	NUT - NYLOC - 8mm x 1.25mm - S/S	8
11	525-024-200	HOSE - AIR ENTRY	1
12	525-023-200	ADAPTOR - AIR CLEANER	1
13	000-958-300	POP RIVET - 4.8mm x 12mm	3
14	000-909	CLAMP - HOSE - 80/100mm - S/S	2
15	525-098-200	BOTTLE - RADIATOR OVERFLOW - PLASTIC	1
16	525-098-300	CAP - OVERFLOW BOTTLE - 38mm ID - WHITE	1
17	525-096-000	BRACKET - OVERFLOW BOTTLE MOUNTING	2
18	000-1018-300	BOLT - B/H - 5mm x 0.8 x 8mm - S/S	2
19	000-951-500	SCREW - S/T - 4.8mm x 16mm	2
20	000-917-100	CLAMP - SPRING - 5/16"	1
21	000-530	ADAPTOR - HOSE 8mm/8mm	1
22	000-838-035	HOSE - RADIATOR OVERFLOW EXTENSION	1
23	000-987-100	CABLE TIE - 2.5mm x 100mm	3
24	000-914/B	CLAMP - HOSE SIZE 56 (BLACK)	1
25	525-017-200	TEMPLATE - GUARD PANEL	1

Installation Guide

Fitment to:

- Right Hand Side

Fitting Time:

- 180min

Special Tools:

- 102mm hole saw
- 3.5mm, 5.0mm & 8.0mm Drill Bits
- Step drill
- Masking Tape
- Pop-rivet gun
- Loctite 243 (threadlocker)
- Sikaflex 227 (Adhesive sealant)
- Touch-up paint
- Body Saw (reciprocating)

Prior to commencing the installation, it is the installer's responsibility to verify that all components and particularly the template (Item 25) are correct.

1

Remove the following in accordance with the factory service manual:

- RHS Mud flap
- RHS Inner guard liner
- Air cleaner assembly

2

Remove and discard the air intake duct and overflow bottle (retain coolant).

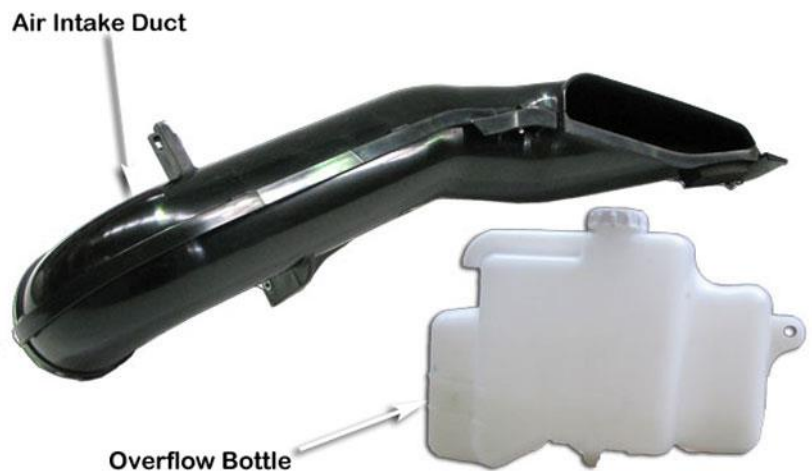

Tape the guard panel template (Item 25) to the rear, upper edges and front of the right hand side guard panel as shown. With the template correctly aligned on the guard panel, use a felt tip pen to mark all hole positions.

Remove the Template.

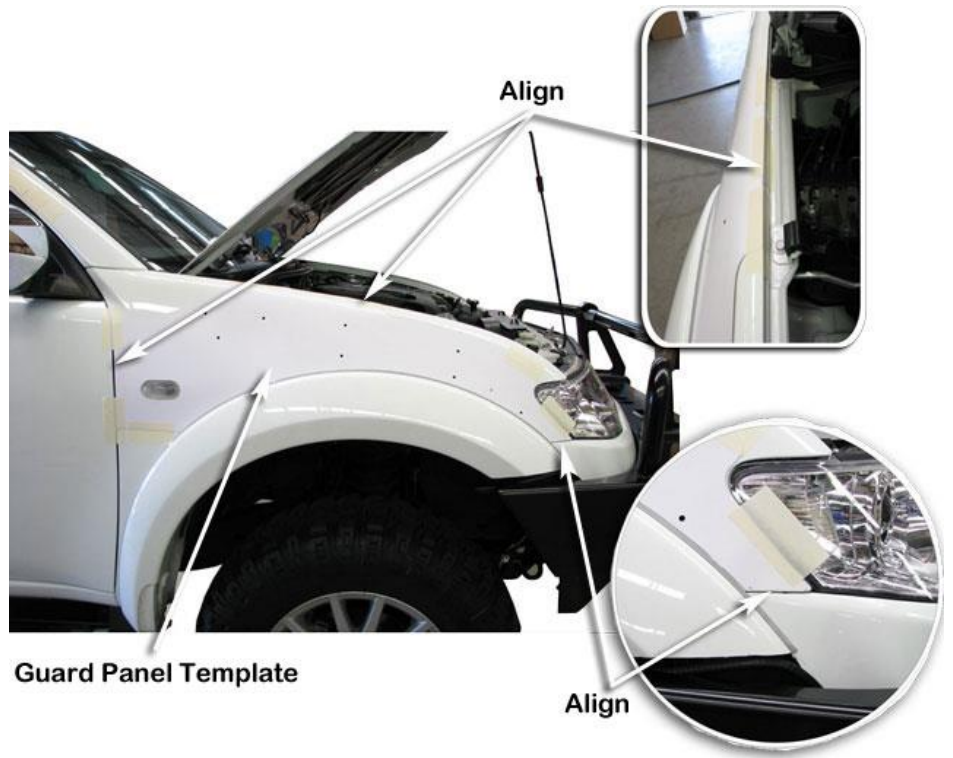

Place a strip of masking tape along the flare and guard panel as shown.

Drill a pilot hole for each marked hole position.

Using the 102mm hole saw, drill the main hole through the section of flare and then square to the guard panel surface (hole saw cutting on both top and bottom surfaces of the guard panel) as shown.

Using the step drill, drill the 8 mounting hole positions to 16mm.

Deburr and paint holes to prevent rust.

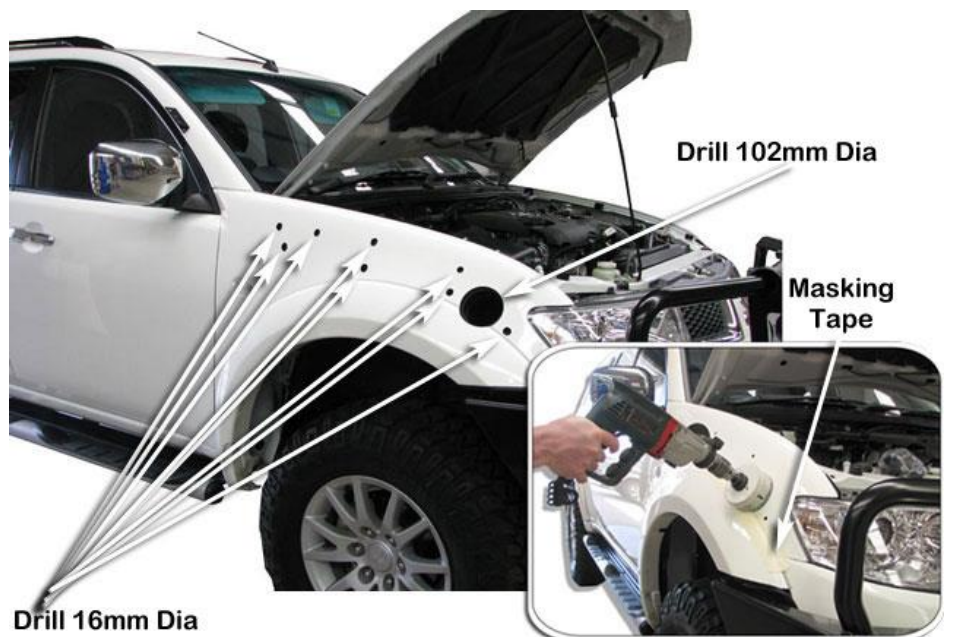

Use the overflow bottle front mounting hole position as a centering guide for drilling the inner guard hole.

Unclip the wiring loom to prevent the loom from being damaged during the hole sawing process.

Use the 102mm hole saw to drill the inner guard and internal panel.

Deburr holes then gently tap the two sharp edges of the internal panel using a piece of timber and a hammer as shown.

This will prevent the air entry hose from being damaged when installed into position.

(If necessary use the body saw to trim away the thin section of internal panel shown).

Paint holes to prevent rust.

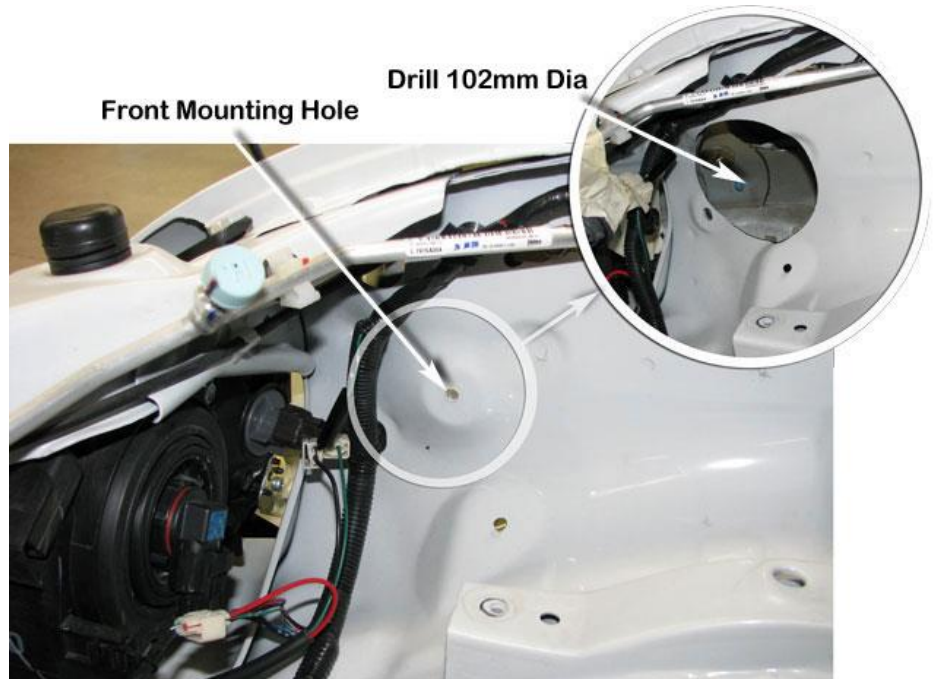

NEW ZEALAND INSTALLATIONS ONLY :

Safari have developed 2 methods of Snorkel A pillar attachment, for the conventional method please proceed with the current document alternatively please see the link below for further instructions.

www.safari4x4.co.nz/apillarmounting

6

Install the Upper Mounting Bracket (Item 3) to the Snorkel Body (Item 1) with hex bolts (Item 4).

Apply Loctite 243 to each of the stainless steel mounting studs (Item 7) and install the studs finger tight into the snorkel body (Item 1) mounting inserts.

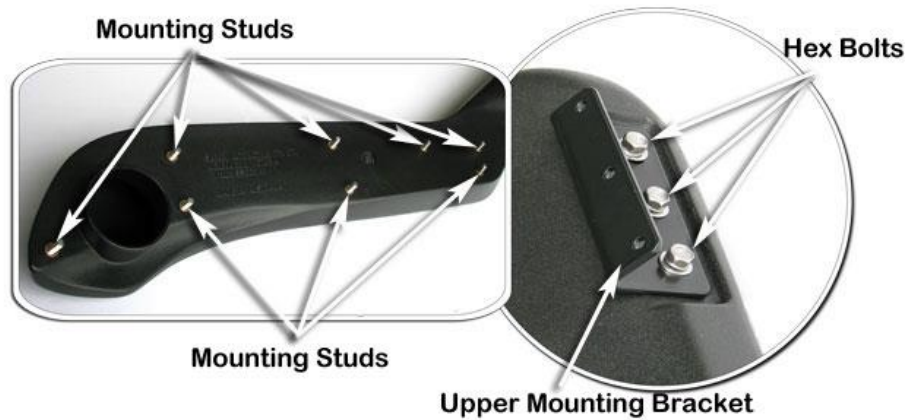

7

Place a strip of masking tape along the A-Pillar panel.

Carefully install the snorkel body (Item 1) onto the guard panel.

With the snorkel body correctly positioned, mark the position of the three upper mounting bracket hole positions on the A-Pillar.

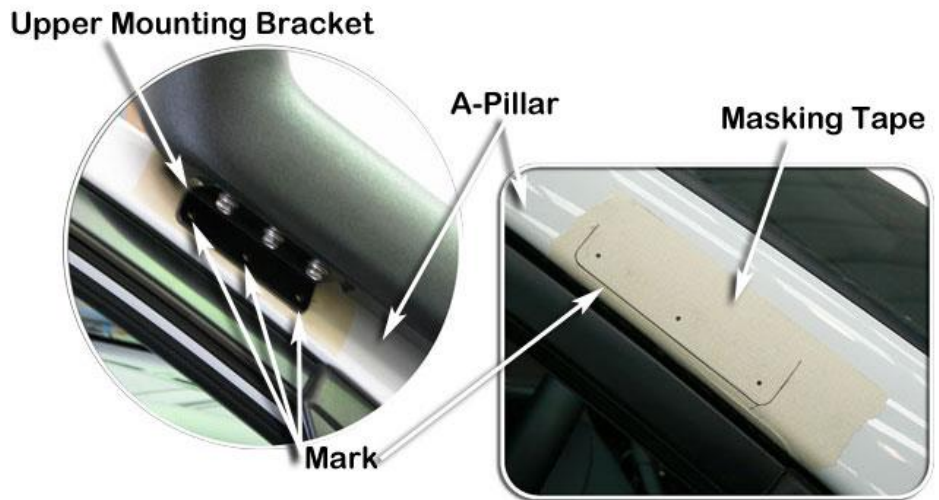

Remove the snorkel body (item 1) from the vehicle and remove the upper mounting bracket (item 3) from the snorkel body.

Drill a pilot hole for each of the three marked hole positions. Drill each hole to 8mm diameter.

NB: Extreme care must be taken when drilling the three A-Pillar mounting hole positions. Ensure that the drill bit is just long enough to drill through the thickness of the A-Pillar panel and no further.

Deburr and paint the holes.

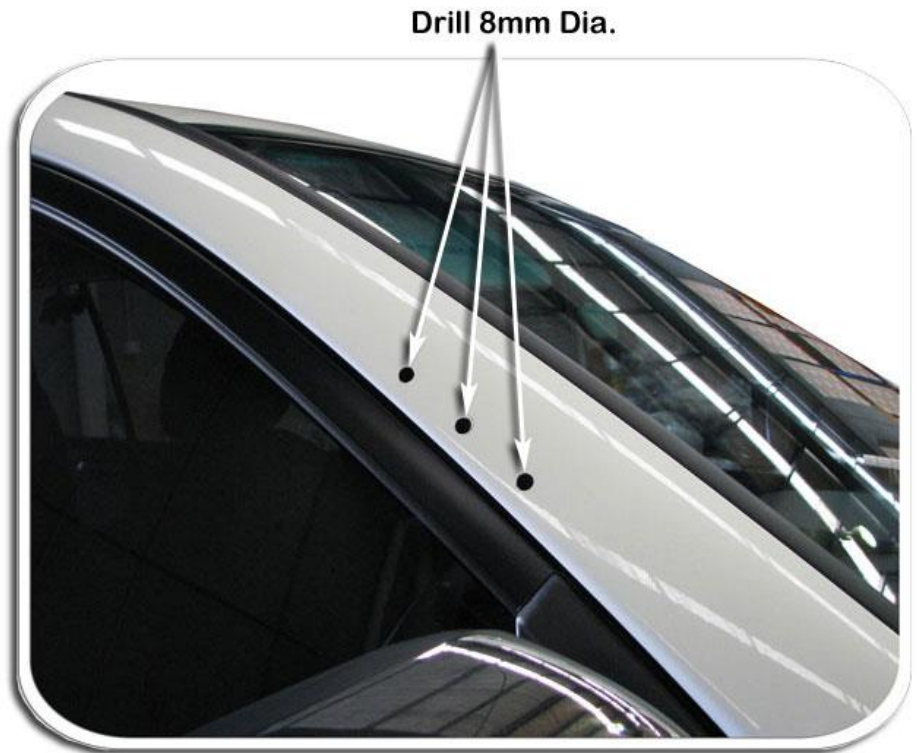

Install the plastic inserts (Item 6) into the upper mounting bracket holes in the A-Pillar.

Secure the upper mounting bracket (item 3) to the A-pillar with three stainless steel self tapping screws (item 5).

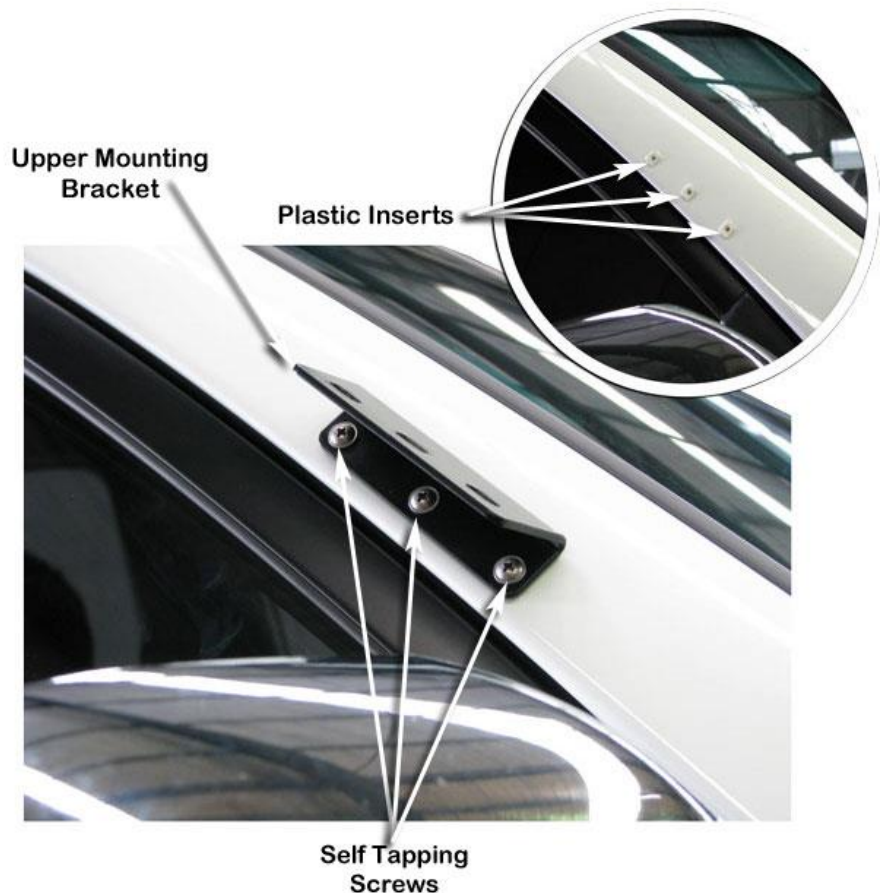

10

Use a sharp knife to trim three of the front air cleaner housing ribs to approximately 12mm in length, as shown.

This will ensure that the air cleaner adaptor (Item 12) sits flat against the air cleaner housing.

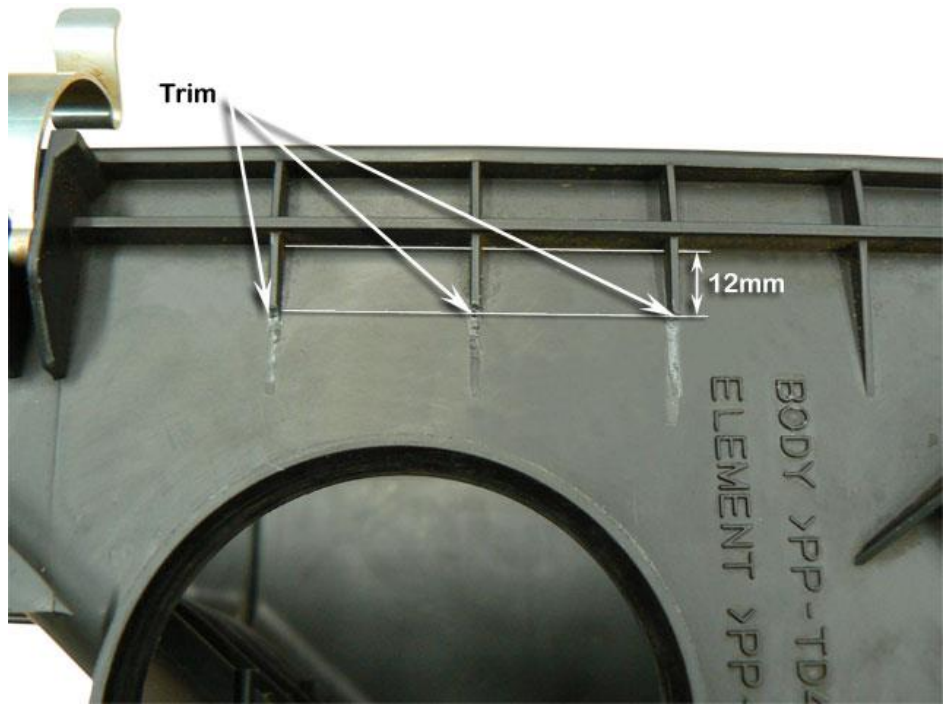

11

Position and align the air cleaner adaptor (Item 12) over the air cleaner inlet snout and mark the 3 hole positions.

Remove the air cleaner adaptor and drill the three marked hole positions with a 5mm drill bit.

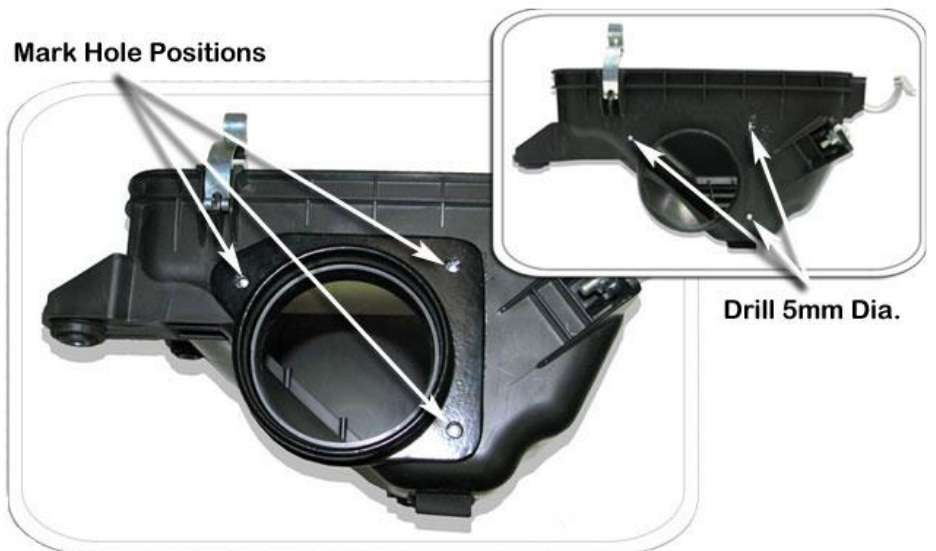

12

Apply a liberal amount of adhesive sealant to the air cleaner adaptor flange (Item 12) and around the external surface of the air cleaner inlet snout.

Insert all three pop rivets (Item 13) and then secure the air cleaner adaptor to the air cleaner housing.

Clean up any excessive sealant to produce a neat finish.

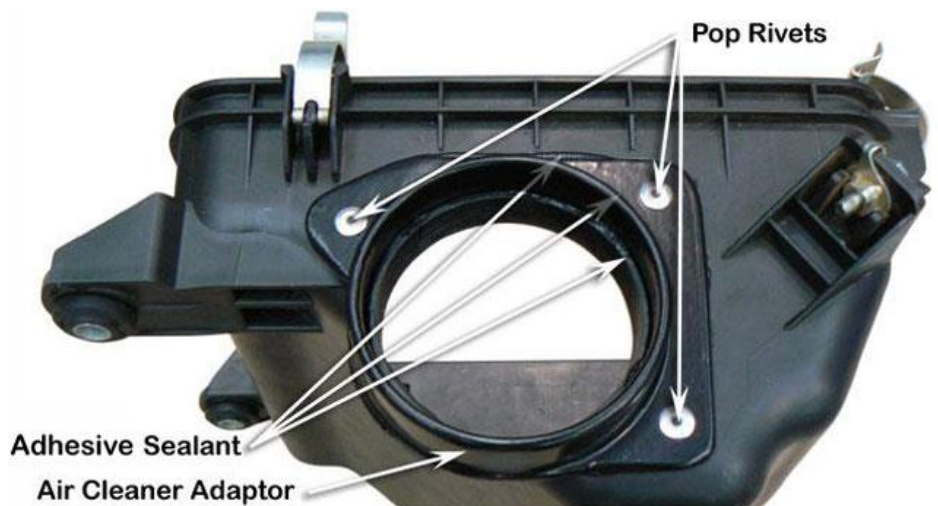

13

Install the two overflow bottle mounting brackets (Item 17) to the radiator overflow bottle (Item 15) (note orientation of brackets) and secure with button head bolts (Item 18).

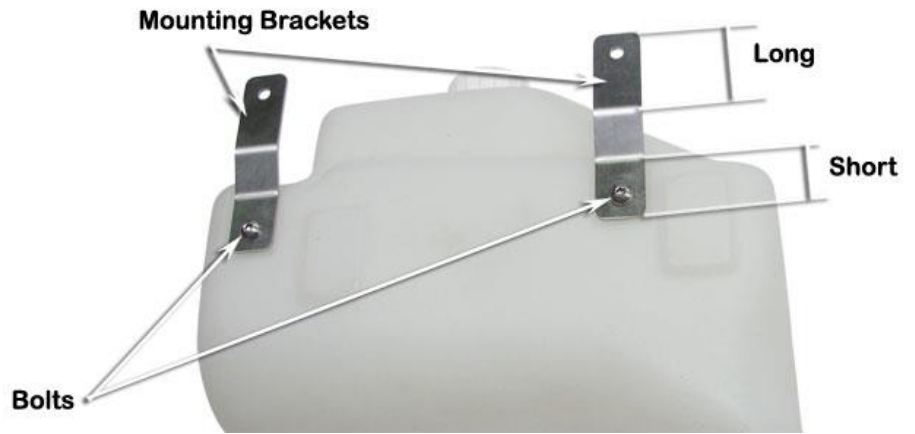

14

Unclip the air conditioning pipe from the pipe support clips and move any wiring that may be in the way.

Place the overflow bottle assembly against the engine bay panel and guide the overflow bottle mounting lug into the mounting lug hole. With the overflow bottle correctly positioned, mark the mounting bracket hole positions onto the panel.

Remove the overflow bottle and drill the two hole positions with a 3.5mm drill bit.

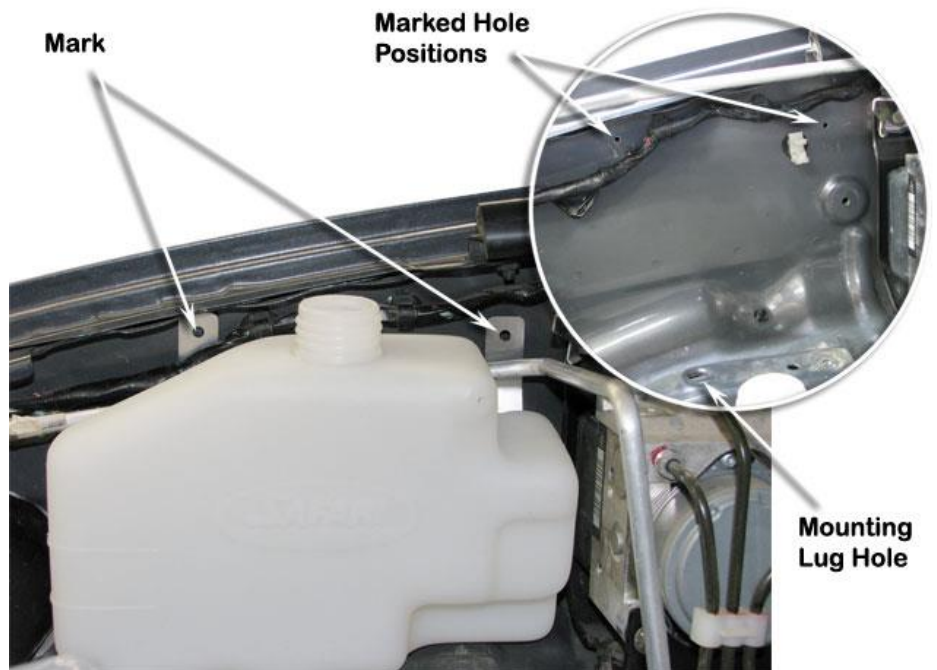

15

Install the spring clamp (Item 20) over the end of the overflow extension hose (Item 22) and install the extension hose onto the overflow bottle (Item 15).



Install the air entry hose (Item 11) through the inner guard hole. Position a 80/100mm hose clamp (Item 14) at each end of the hose.

Install the overflow bottle into position and route the extension hose (Item 22) under the air entry hose and out towards the front of the engine bay.

Install the air cleaner base and fasten with the original mounting bolts.

Loosely install the air entry hose (Item 11) onto the air cleaner adaptor (Item 12).

Secure the overflow bottle into position with two self tapping screws (Item 19).

Secure the air conditioning pipe back into the pipe support clips.



Route the overflow extension hose to meet with the standard overflow hose.

Trim the standard overflow hose to the required length and join the two hoses together with the plastic adaptor (Item 21).

Secure the overflow extension hose with cable ties (Item 23).

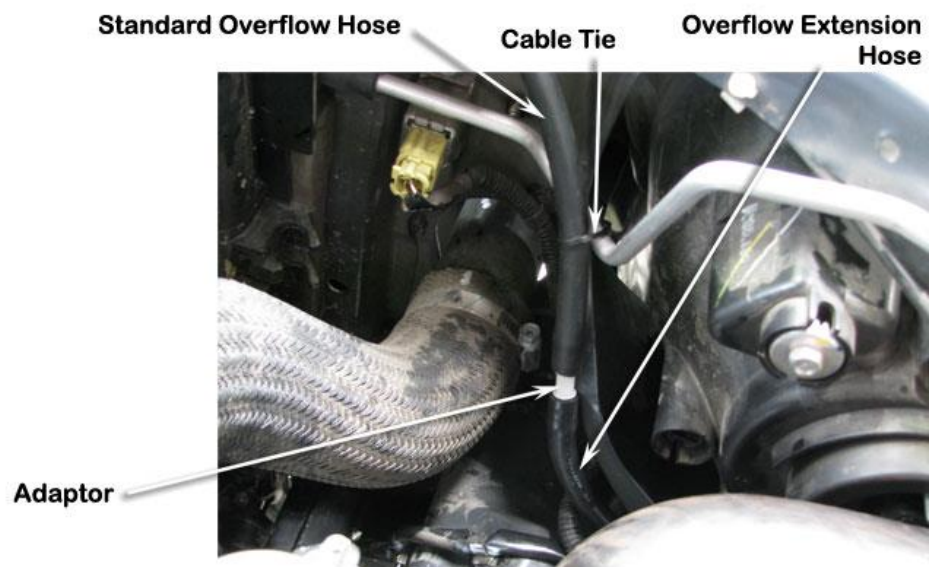

With the air entry hose (Item 11) positioned loosely, carefully guide the snorkel body outlet snout into the air entry hose and install the snorkel body to the guard panel.

Align the snorkel body to the upper mounting bracket and the guard panel. When correctly aligned, fasten the snorkel body to the guard panel with body washers (Item 9) and Nyloc nuts (Item 10).

Fasten the snorkel body to the upper mounting bracket with hex bolts (Item 4).

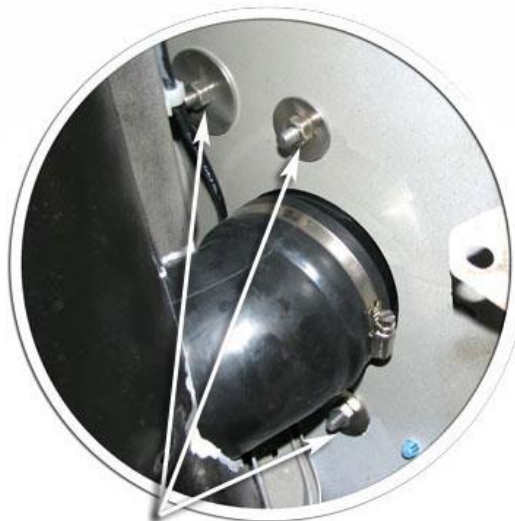

Body Washers and Nyloc Nuts



Hex Bolts

Ensure that the air entry hose is correctly positioned onto the snorkel body snout and air cleaner adaptor.

Orientate the 80/100mm hose clamps (Item 14) into position and tighten.

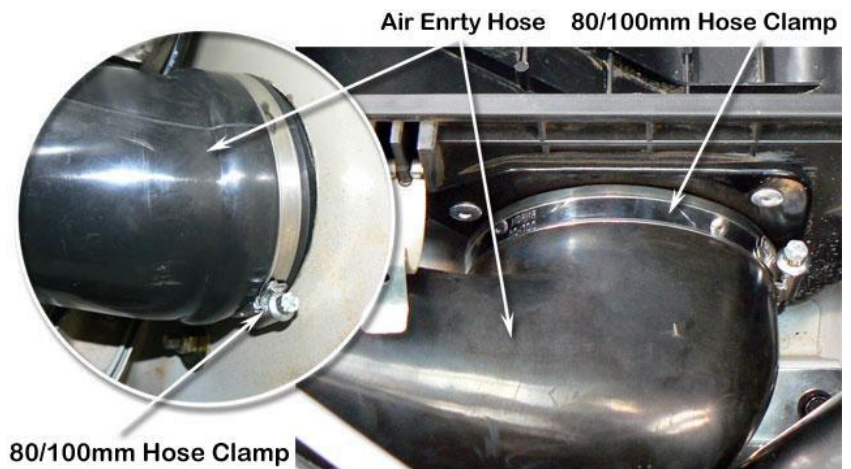

20

INSTALLER OPTION

The air cleaner housing base contains a drain valve as shown. This can permit water to enter the air intake.

It is up to the installer to decide whether the drain valve should be sealed.

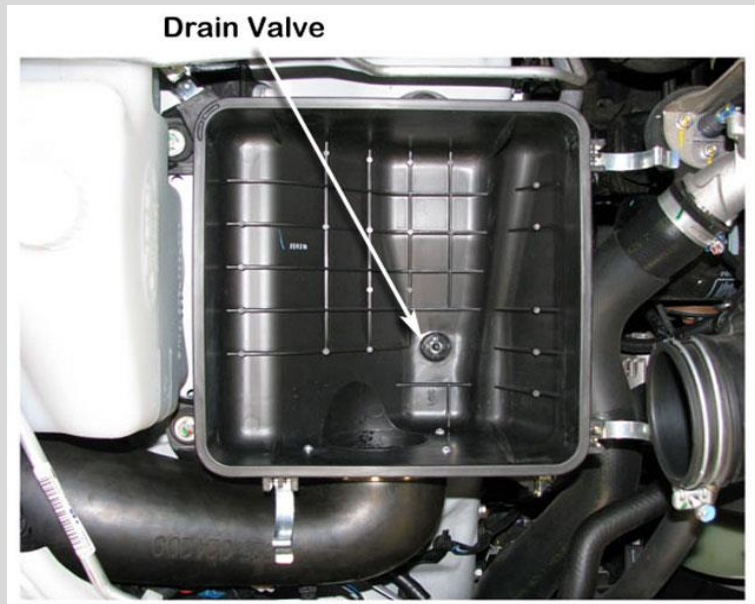

21

Install the air cleaner element, air cleaner housing lid and connect the air mass sensor wiring plug.

Refill the overflow bottle with the coolant retained previously and top up if necessary. Install the overflow bottle cap (Item 16).



22

Loosely install the black hose clamp (Item 24) to the base of the air ram assembly (Item 2). Install the air ram assembly onto the snorkel body.

Align the air ram assembly and tighten the black hose clamp (Item 24).



23 Install the guard liner, mud flap and any other items that may have been removed during the snorkel installation process.

24 **N.B:** It is the installer's responsibility to ensure that all connections are water tight.