



4X4 ENGINEERING

SMIVDJ70M – with DVVC

**TOYOTA LANDCRUISER 70 SERIES 1VD-FTV 2012 –2016
(Euro 4) ALL MODELS**

PATENT PENDING





WARNING!!

The Safari Armax Engine Control Unit (ECU) CANNOT be used in conjunction with any aftermarket electrical device, micro controller or altered/reflashed OE control unit which influences the operation of the OE control unit and/or the operation of the vehicles drivetrain, without specific written consent from Safari 4x4 Engineering Pty Ltd, failure to seek written consent will void all claims against vehicle drivetrain warranties which Safari 4x4 Engineering offer as part of this system.

Parts List

ITEM	PART NO	DESCRIPTION	QTY
1	000-081-700	SAFARI ARMAX ECU	1
2	333-283-000	WIRING LOOM AM2P	1
3	370-283-150	WIRING LOOM AM2P IN CAR	1
4	000-716-200	MOUNT-DTM	1
5	000-082-000	SWITCH-5 POSITION-ECU	1
6	000-088-100	EGT THERMOCOUPLE ASSY	1
7	333-289-001	BRACKET - MOUNTING A	1
8	333-289-951	BRACKET - MOUNTING B	1
9	333-289-201	BRACKET - MOUNTING C	1
10	333-289-301	BRACKET - MOUNTING D	1
11	333-289-401	BRACKET - MOUNTING E	1
12	333-099-500	BRACKET - MOUNTING - DIP STICK	1
13	000-001-500	BOLT - M6 X 12MM SEMS SS	3
14	000-001-600	BOLT - M6 X 15MM SEMS SS	4
15	000-003-400	BOLT - M6 X 20MM SEMS SS	4
16	000-1013-400	BOLT - M8 X 25MM SEMS SS	1
17	000-987-290	CABLE TIE - 4.8MM X 280MM	35
18	000-987-100	CABLE TIE - 2.5MM X 100MM	2
19	000-717-500	BRIDGE OUT CONNECTOR-AM2P	1
20	333-283-950	RESISTOR	1
21	000-093-100	BOLT – BH - M4 X 10MM S/S	4
22	000-300-300	WASHER - FLAT - M4 S/S	4

AUXILLARY PARTS (AVAILABLE SEPERATELY)

ARB COMPRESSOR BRACKET

23	333-289-101	BRACKET - MOUNTING - ARB COMPRESSOR	1
----	-------------	-------------------------------------	---

DUAL DIAPHRAM BRAKE BOOSTER BRACKET - SMPVDJ70MDD

24	333-289-976	BRACKET - MOUNTING - DUAL DIAPHRAM	1
----	-------------	------------------------------------	---

25	000-255-400	NUT - M8 FLANGE SS	2
----	-------------	--------------------	---

HYDRO BRAKE BOOSTER BRACKET- SMPVDJ70MHB

26	333-289-981	BRACKET – MOUNTING – HYDRO BOOSTER A	1
----	-------------	--------------------------------------	---

27	333-289-982	BRACKET – MOUNTING – HYDRO BOOSTER B	1
----	-------------	--------------------------------------	---

28	333-289-983	BRACKET – MOUNTING – HYDRO BOOSTER C	1
----	-------------	--------------------------------------	---

29	000-255-400	NUT - M8 FLANGE SS	2
----	-------------	--------------------	---

Installation Guide

Pre installation checklist:

- Check engine oil level
- Check fuel filter condition
- Check air filter condition
- Check for pre existing fault codes
- Check injector compensation values are within manufacturers specification.
- Check vehicle doesn't blow excessive smoke
- Check for other performance devices/controllers

Any faults must be rectified prior to the installation of the ARMAX ECU. Contact Safari 4x4 engineering for further information.

1

Disconnect battery earth wire

BRACKET DIAGRAM 1

2

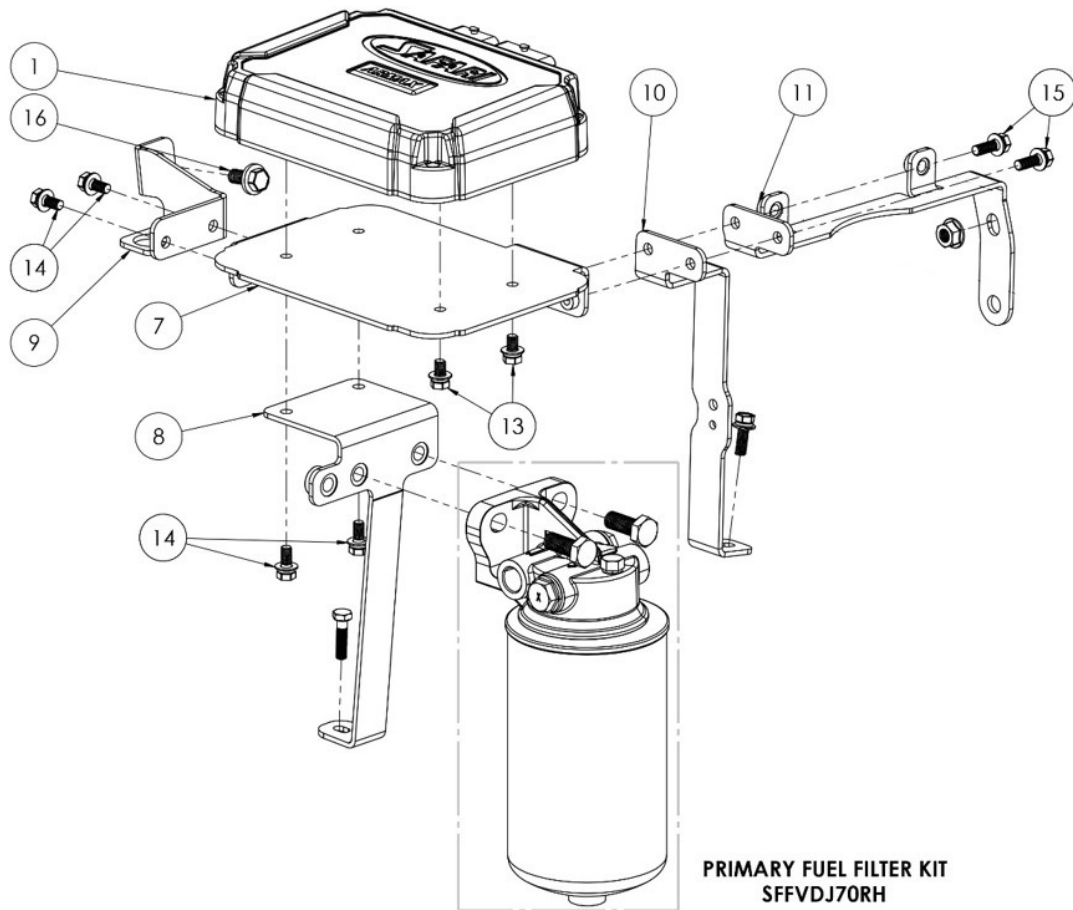

3 If the vehicle is fitted with the OE brake booster go to **Step 4**

If the vehicle is fitted with a Dual Diaphragm brake booster go to **Step 4**

If the vehicle is fitted with a Hydro Brake Booster skip to **Step 6**

4

Remove the left hand side nut from the master cylinder.

Remove nut

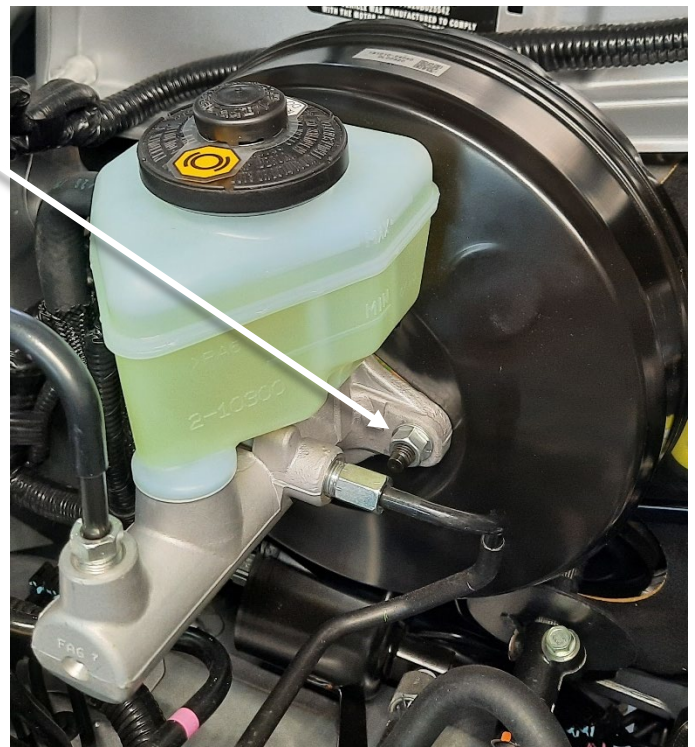

Install mounting bracket E (item 11) as shown to the master cylinder and secure using the retained OE nut.

If the vehicle is fitted with a **Dual Diaphragm brake booster** replace mounting bracket E (item 11) with SMPVDJ70MDD dual diaphragm mounting bracket (item 24) purchased separately.

**Continue to
Step 10.**

Mounting
bracket E
(item 11)

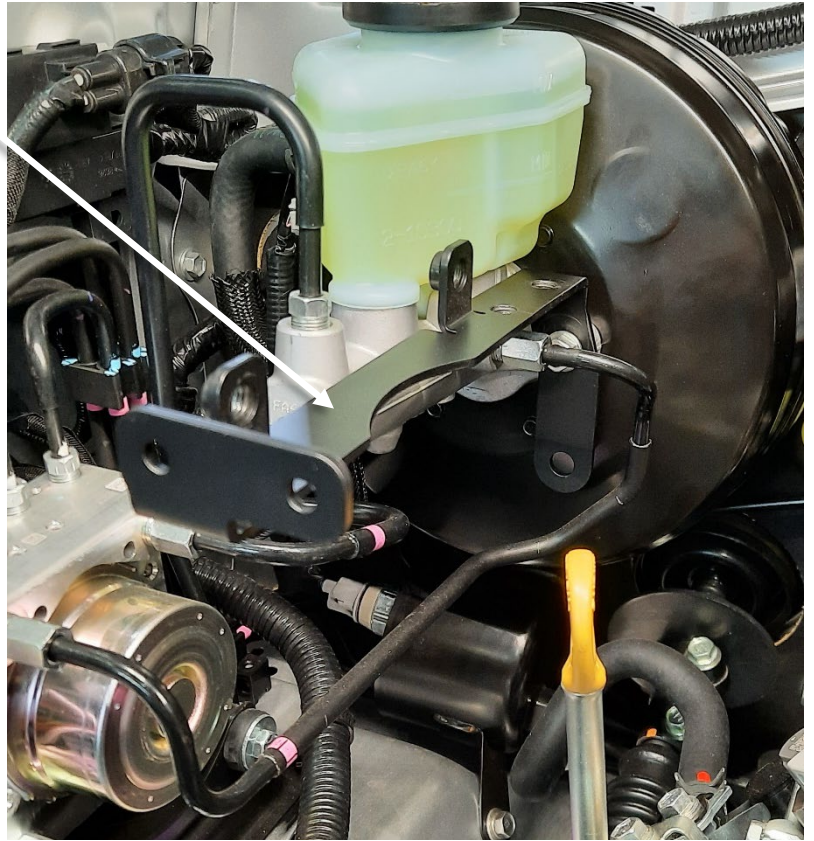

Hydro brake booster bracket installation- Steps 6 - 9

6

Remove bolt

Remove the upper bolt from the hydro booster master cylinder adapter and retain.

Remove the left hand side nut from the brake master cylinder and retain.

Remove nut

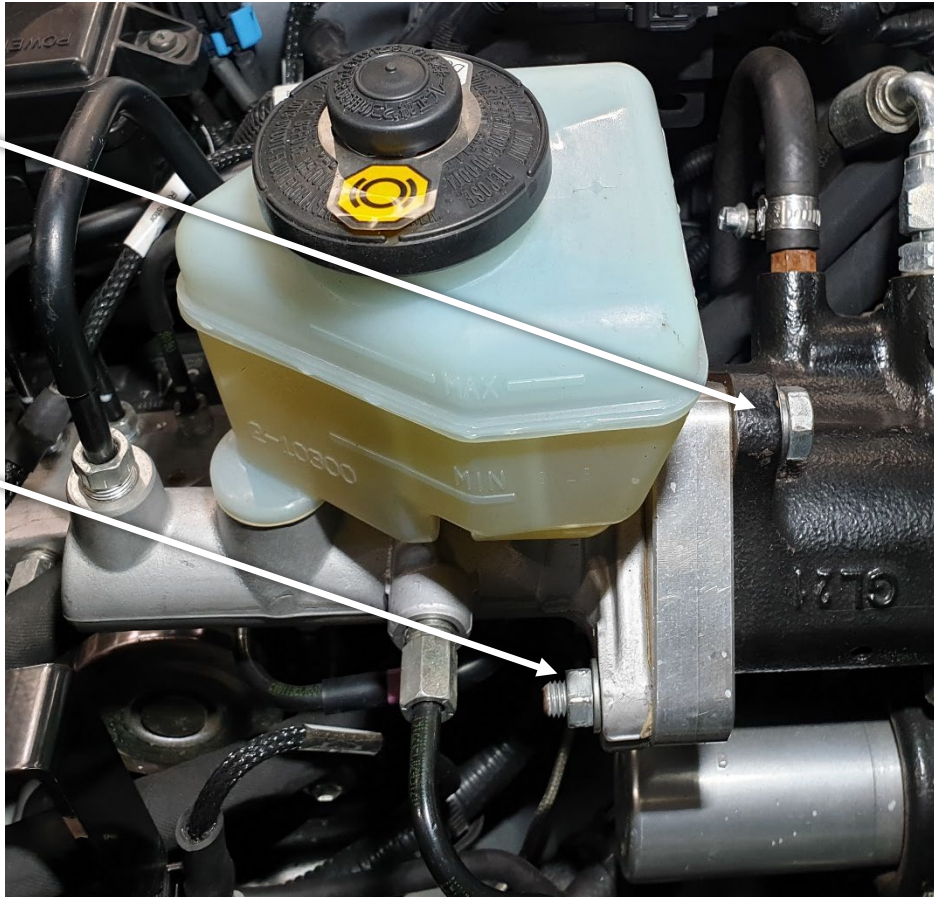

7

Using the retained bolt, install hydro booster mounting bracket C (item 28) as shown.

Do not fully tighten bolt.

Hydro booster mounting bracket C (item 28)

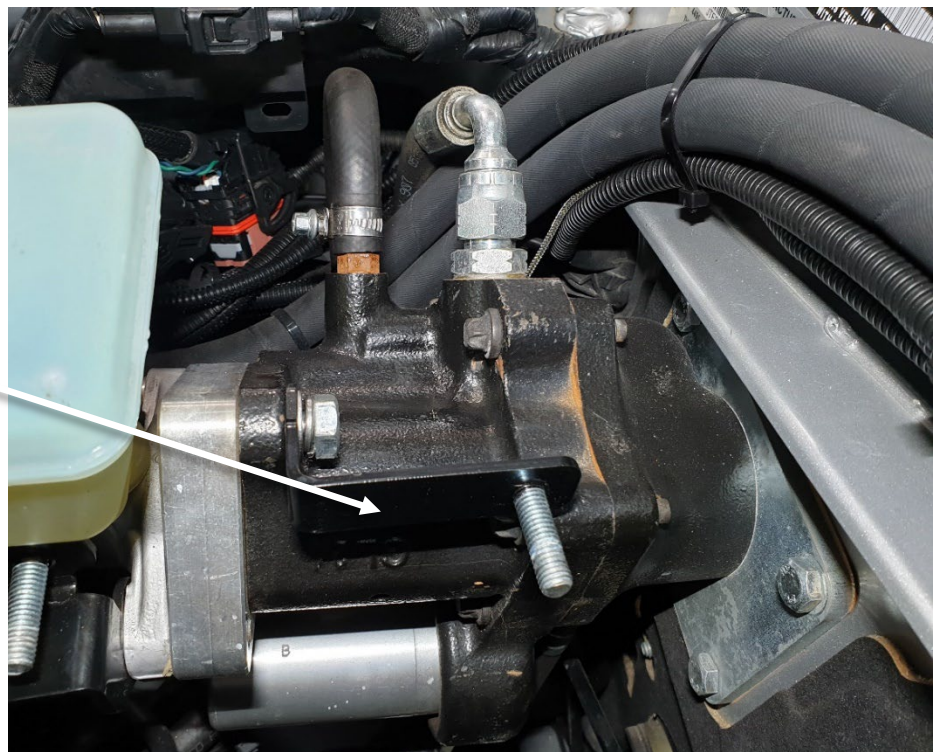

Hydro booster mounting bracket A (item 26)

Using the retained O.E nut, install the hydro booster mounting bracket A (item 26) to the master cylinder.

Do not fully tighten nut.

O.E Nut



Install the hydro booster mounting bracket B (item 27) onto the two studs.

If not installing an oil separator fit the 2x M8 flanged nuts on the studs to secure hydro booster mounting bracket B

(Item 27).

Hydro booster mounting bracket B (item 27)

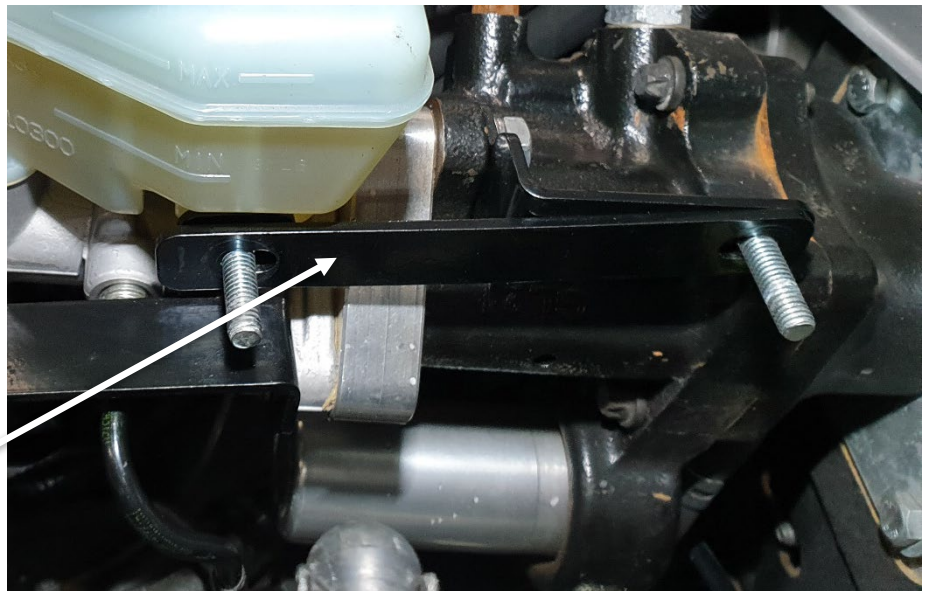

Inner guard bolt hole

Locate the captive nut in the inner guard next to the ABS unit.

Install mounting bracket D (item 10) using a M6x20mm bolt (item 15) but do not fully tighten.

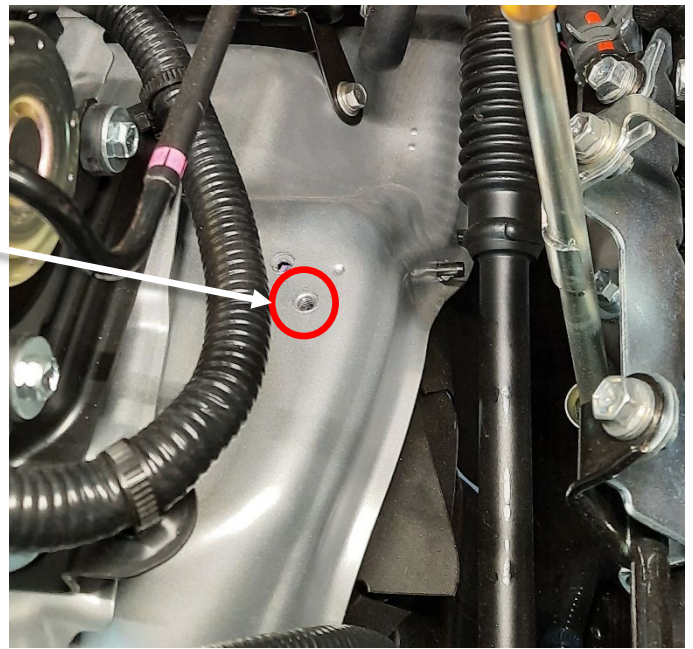

Mounting bracket D (item 10)

M6x20mm Bolt (item 15)

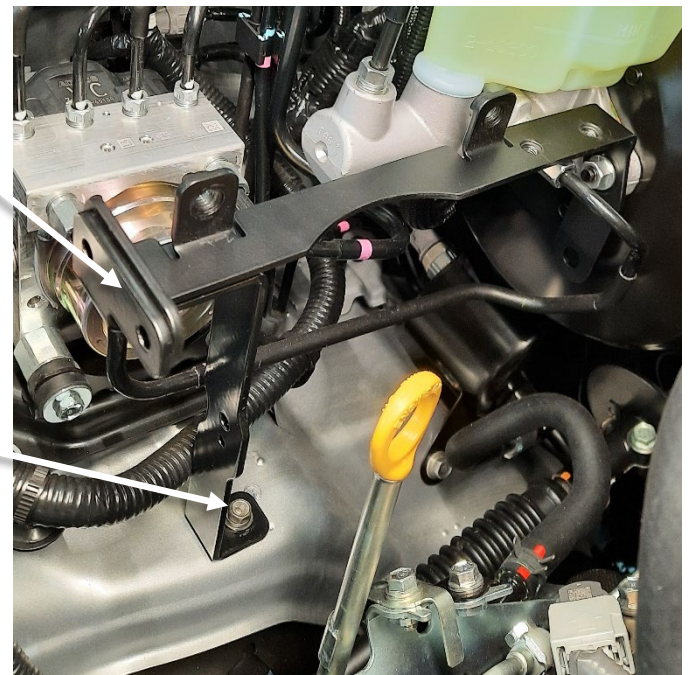

Install mounting bracket C (item 9) to the inner guard next to the power outlet box.

Use a M8x25mm bolt (item 16) but do not fully tighten.

Inner guard
mount position

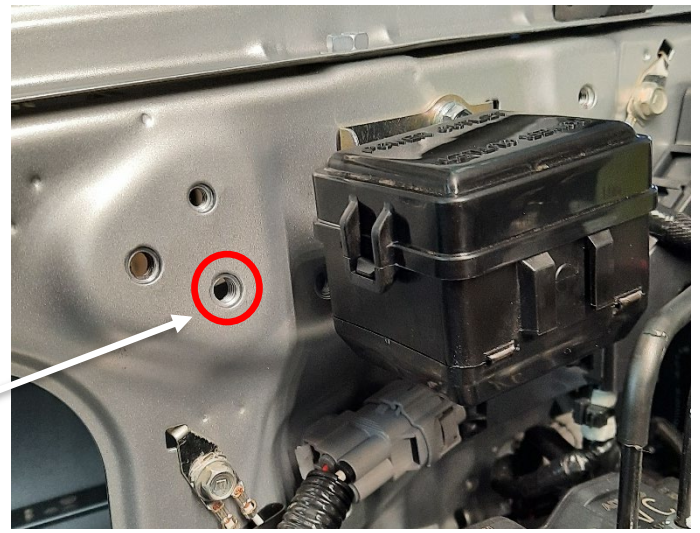

M8x25mm
Bolt (item 16)

Mounting bracket
C (item 9)

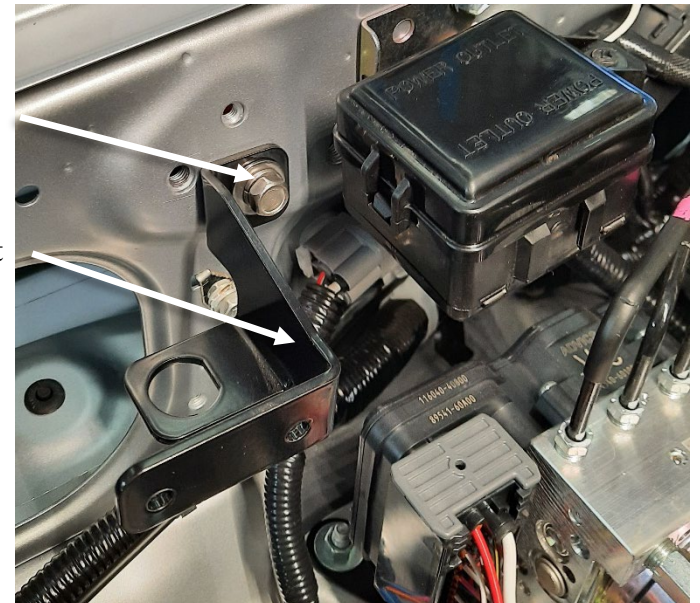

Remove OE bolt from power steering bracket and retain.

Remove

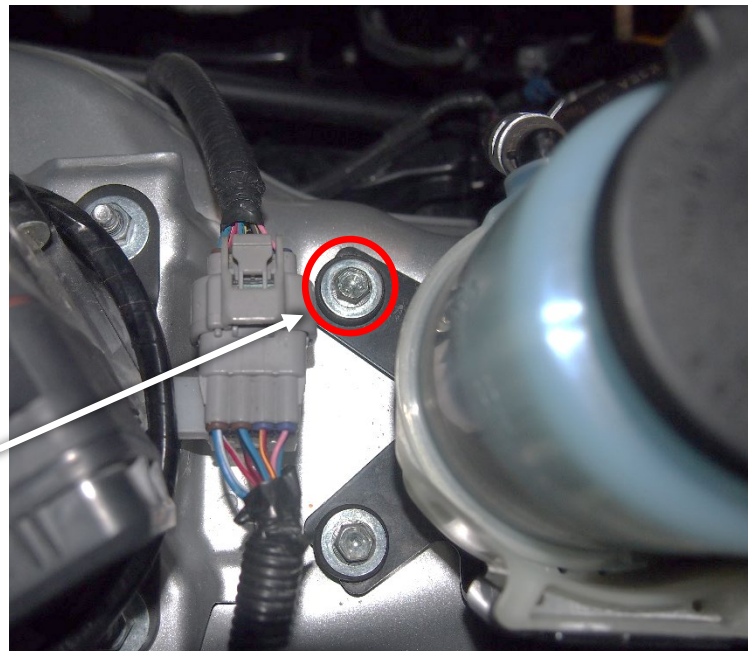

Mounting bracket B
(item 8)

Install mounting bracket B (item 8) onto the power steering reservoir.

Use OE bolt to secure bracket, do not fully tighten.

Use bracket 333-289-101 (item 23) if vehicle is fitted with an ARB compressor in this location.
(purchased separately)

OE Bolt

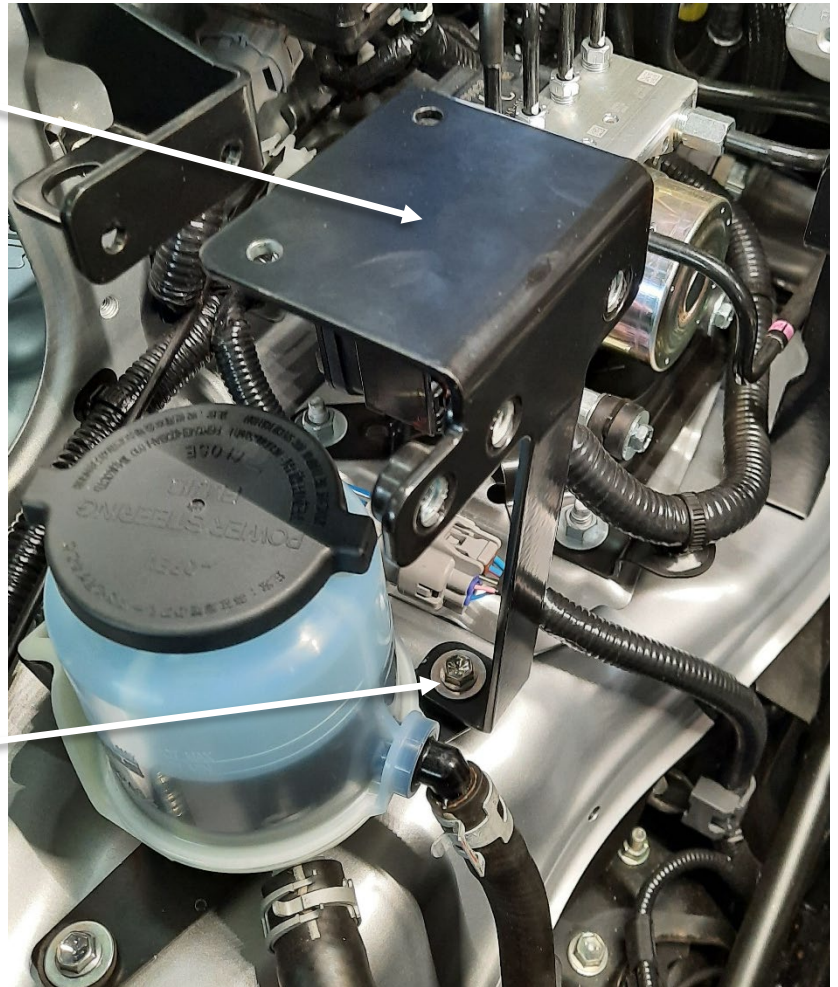

Install Resistor (item 20) onto the supplied Base plate (item 7) using 4 x button head screws and washers (Items 21& 22).



Install the ECU base plate mounting bracket A (item 7). Secure to mounting bracket E (item 11) and D (item 10) using 2x M6x20mm bolts (item 15) and to mounting bracket C (item 9) using 2x M6x15mm bolts (item 14). Do not fully tighten bolts.

Mounting brackets E (Item 11) and D (Item 10)

Mounting bracket C (Item 9)

M6x15mm Bolts (Item 14)

M6x20mm Bolts (Item 15)

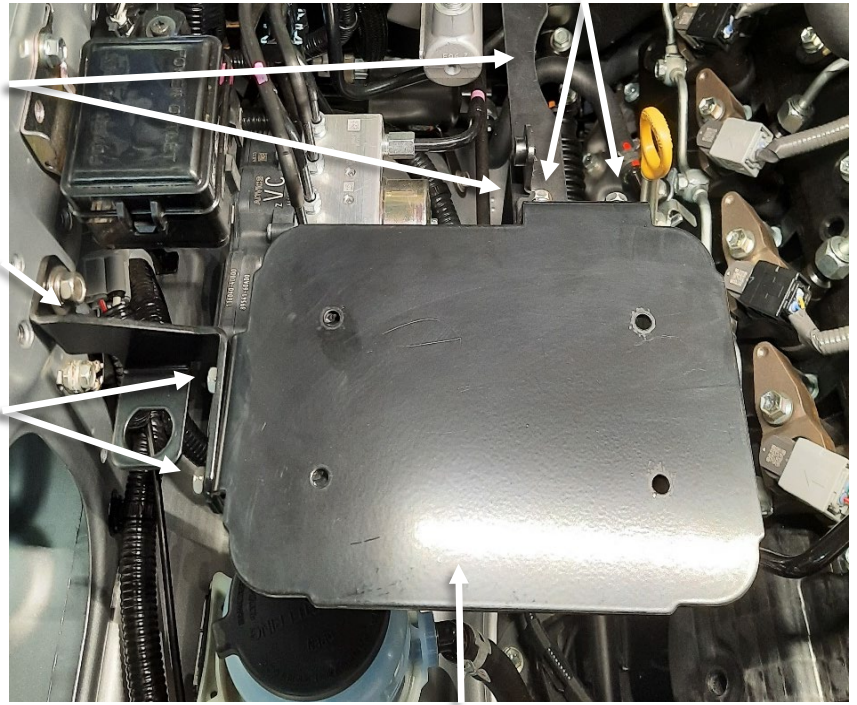

Mounting bracket A (Item 7)

Install the ECU to the base plate - mounting bracket A (item 7). Secure using 2 x M6 x12mm (item 13) and 2 x M6x15mm (item 14) for the 2 bolts that go through mounting bracket B (item 8) and into the base.



M6x15mm Bolts (Item 14)

M6x12mm Bolts (Item 13)

Final tighten all mounting bracket bolts and nuts.

Diagram 2

Red: ARMAX wiring harness

1. In car loom
2. RH Fuel pressure sensor
3. MAP Sensor
4. Crank angle sensor
5. EDU 2
6. EDU 1
7. Main vehicle battery
8. Boost control solenoid
9. Resistor

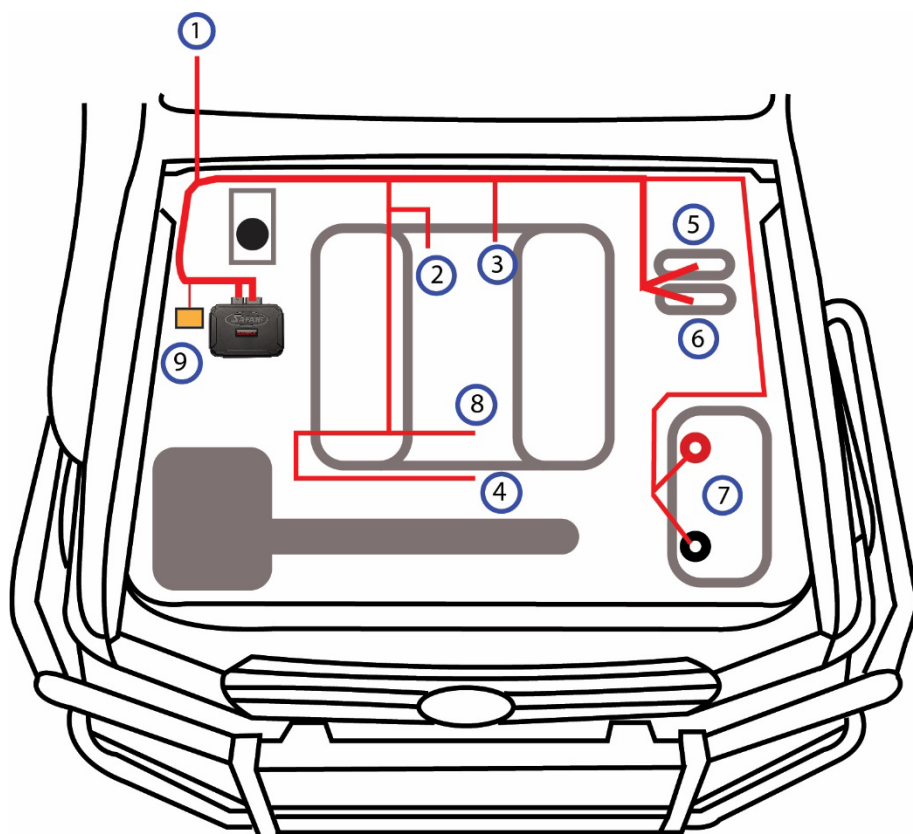

19 Locate the rubber grommet on the firewall located next to the brake master cylinder as shown.

Locate the branch labelled IN CAR LOOM on the main Armax wiring harness.

Pierce a hole in the rubber grommet.

Feed the IN CAR LOOM through the grommet on the firewall and pull through approximately 150mm into the driver's side foot well.

Rubber grommet

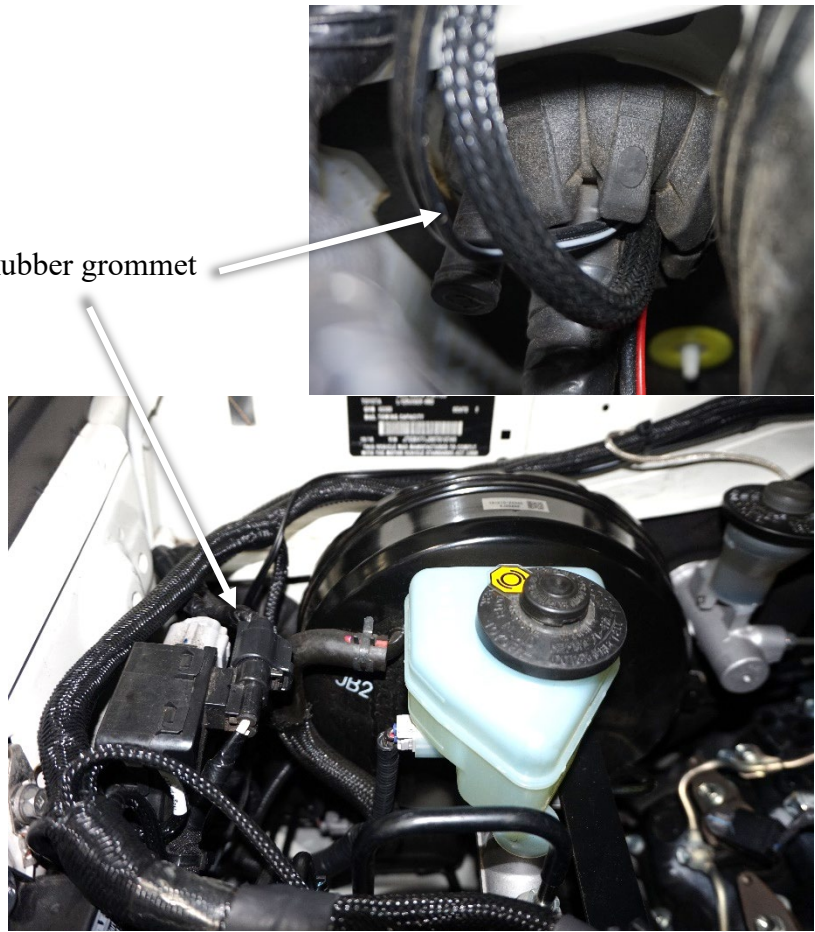

20 Connect the ARMAX loom to the ECU.

Connect the smaller 32 pin plug as shown first. Then connect the larger 48 pin plug in the same manner.

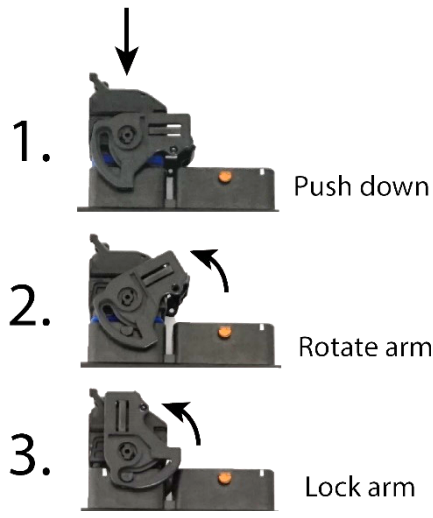

21 Connect the communications cable to mounting bracket C

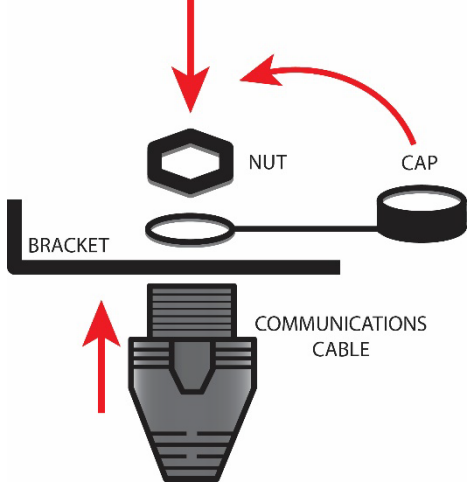

Connect the 2 eyelets on the resistor branch of the supplied wiring harness to the resistor (you can connect the eyelets to the resistor in either polarity configuration). Align the eyelets as shown and tighten in position.

Slide terminal boots over the ends of resistor



Run the loom across the back of the engine along the firewall.

Refer to diagram 2 on page 12.

Route the harness for the Fuel Pressure sensor , Boost Control Solenoid and Crank angle sensor along the top of the RH rocker cover following the injector loom (as shown by the red dotted line).

Continue running the Crank angle sensor harness down towards the back of the alternator at the bottom of the engine

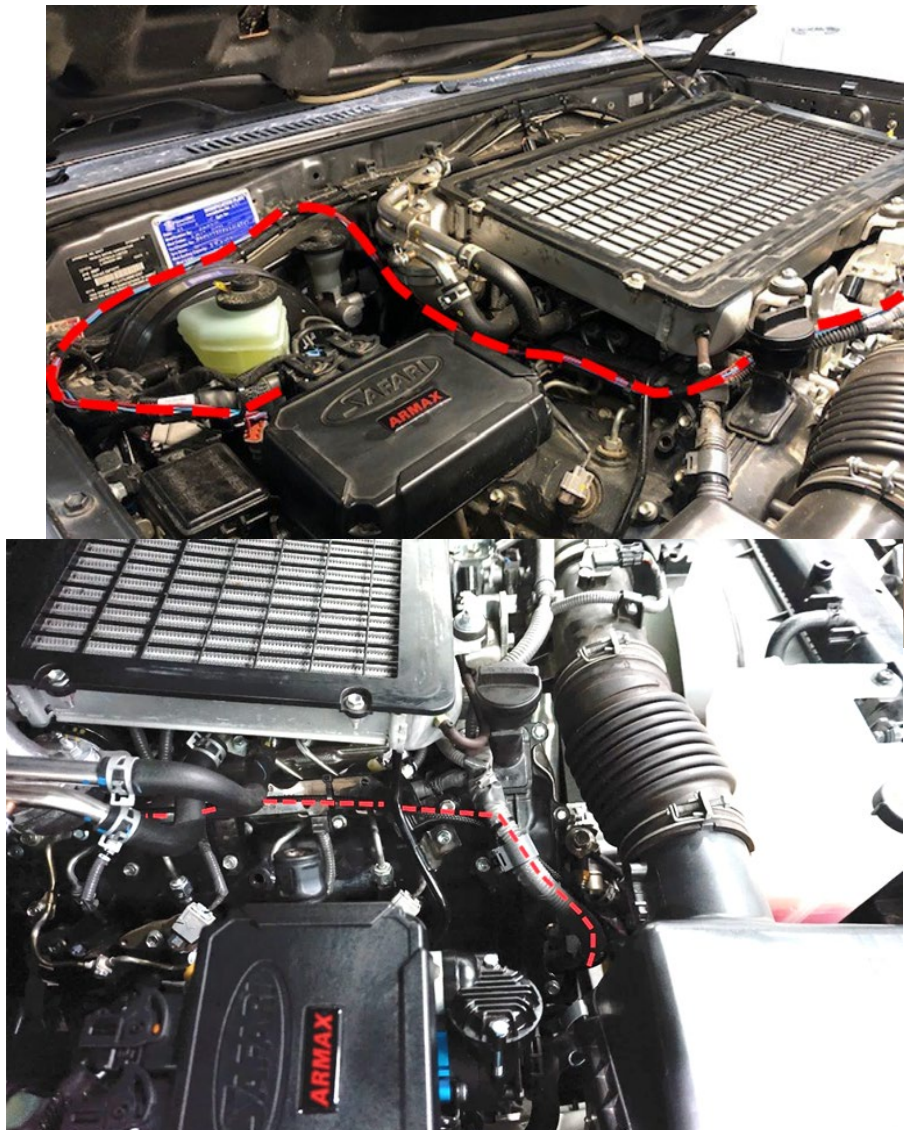

Connect the ARMAX loom to the RH fuel pressure sensor on the RH fuel rail.

The fuel pressure sensor is located at the RH side rear of the engine beneath the intercooler.

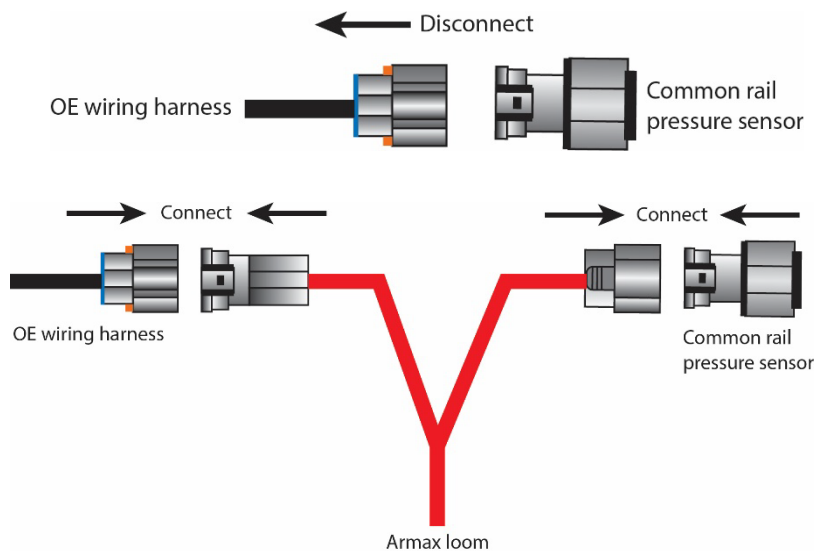

Connect the ARMAX loom to the crank angle sensor connector.

The crank angle sensor connector is located beneath the air conditioning compressor.

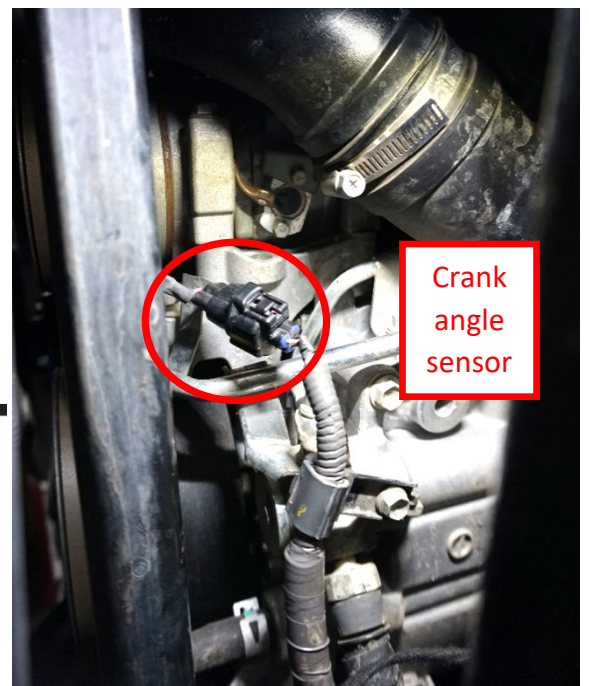
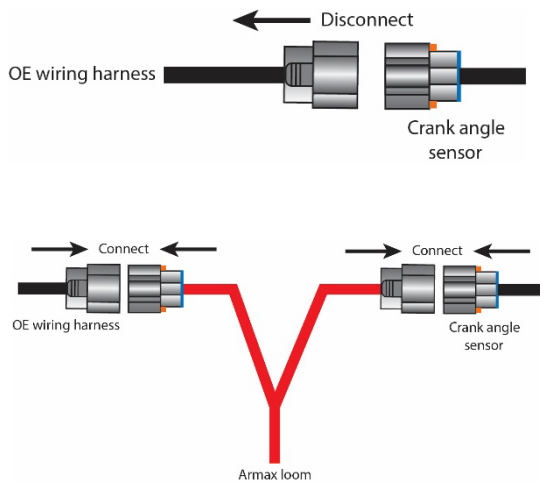

Boost control solenoid

Connect the Boost control harness to the boost control solenoid.

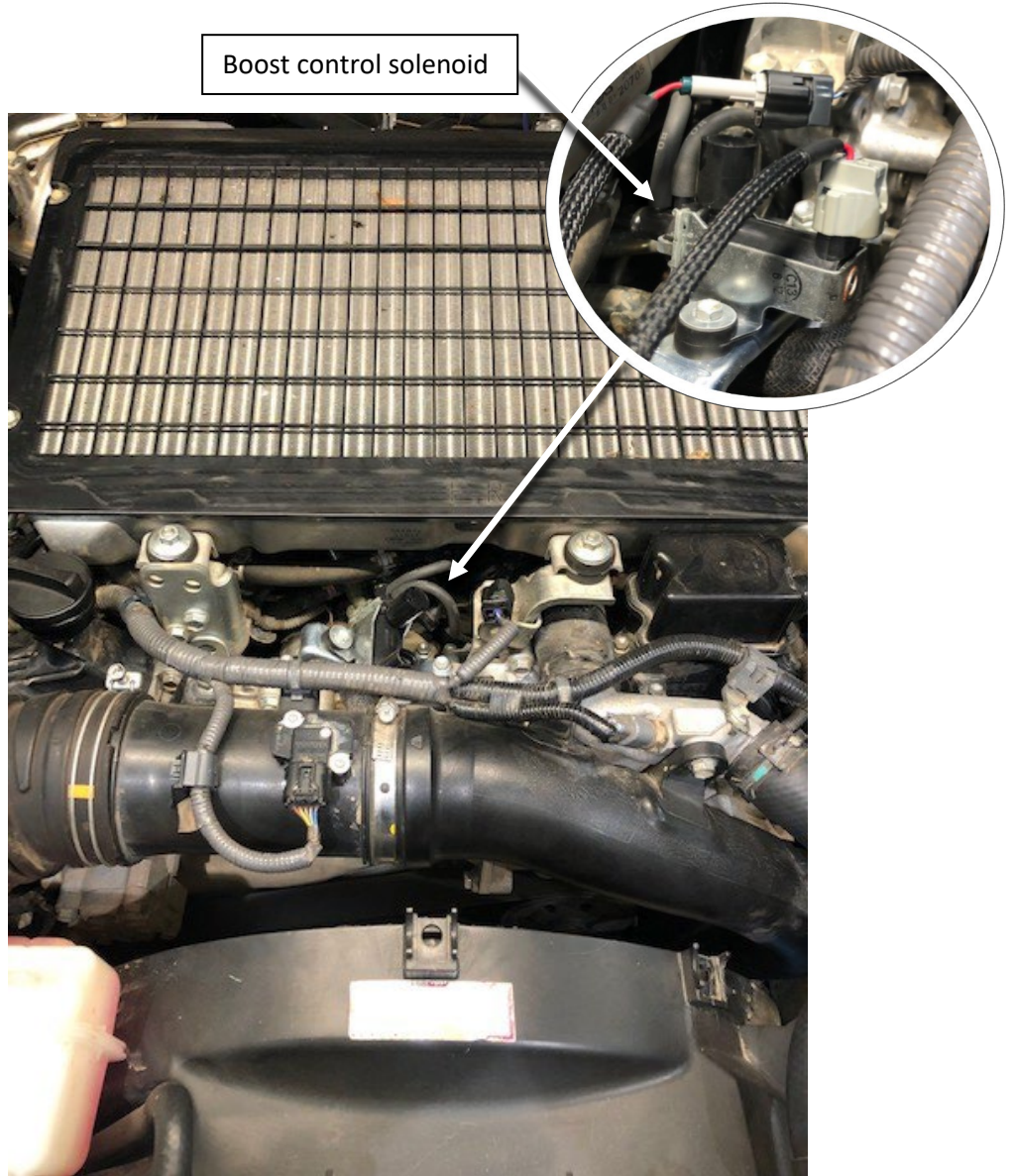

Ensure that the Boost control solenoid harness located next to the Armax ECU is connected to the Standard vehicle harness as shown and plug the blanking cap into the Armax ECU harness as shown.

Caution!!!

Vehicle will trigger check engine light if step not followed correctly.

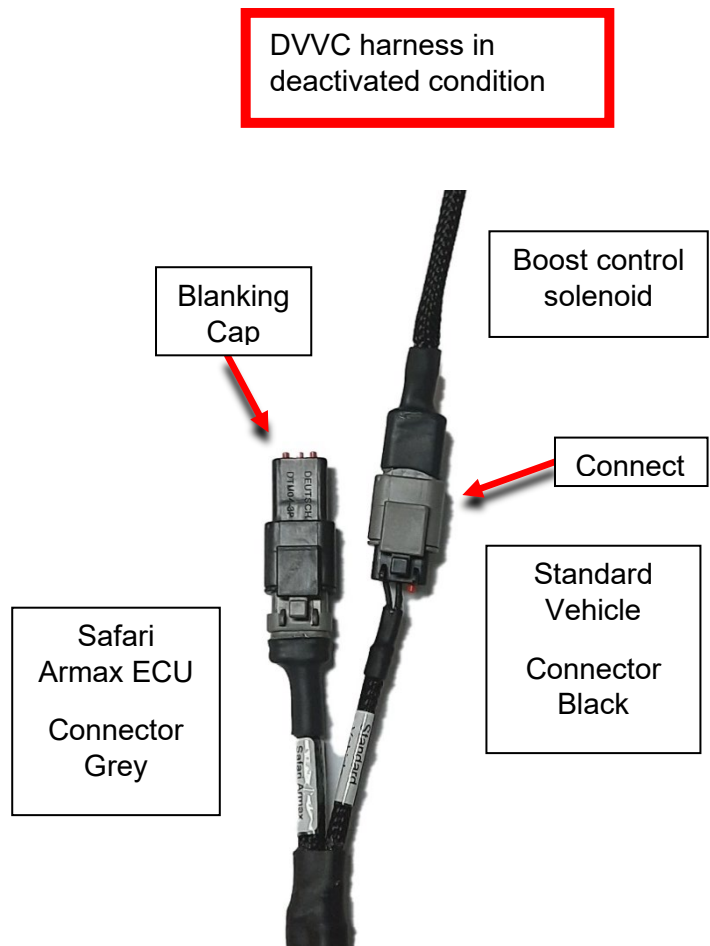

MAP sensor

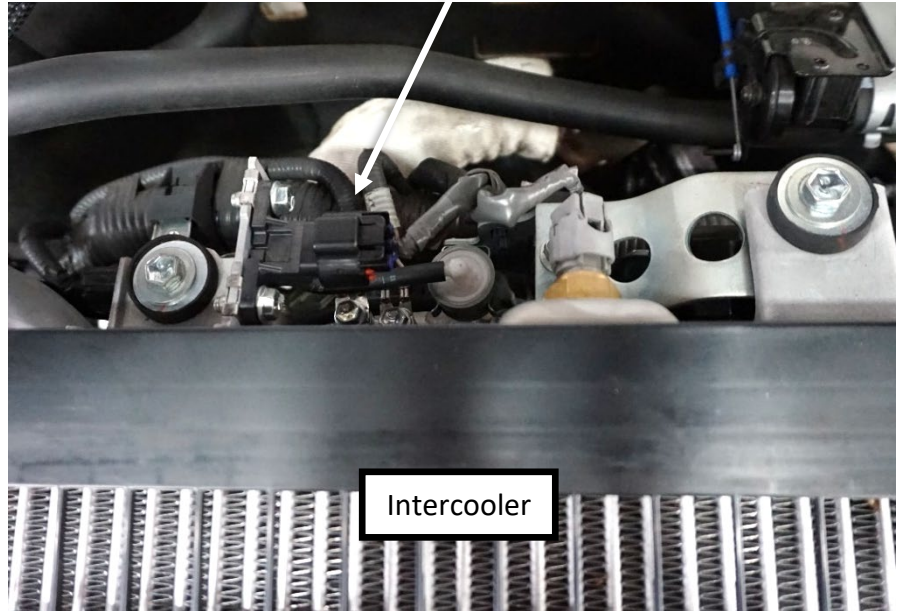

Connect ARMAX loom to the MAP sensor.

The MAP sensor is located at the back of the intercooler.

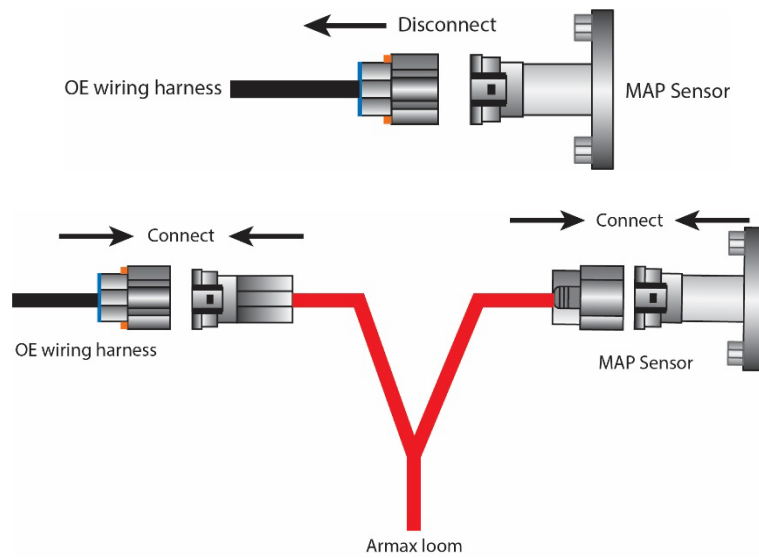



WARNING!

DO NOT CROSS EDU CONNECTORS AS THIS MAY CAUSE ENGINE DAMAGE. PLEASE REFER TO THE PHOTOS AND DIAGRAMS BELOW TO IDENTIFY THE EDU'S. PLEASE CONTACT SAFARI 4X4 FOR FURTHER INFORMATION.

Run loom along the firewall, then run the EDU branch down towards the front of the vehicle alongside the LH cylinder head. Run the EDU loom along the factory loom to the EDU's. (Refer to Diagram 2 on page 7)

Connect the ARMAX loom to EDU's

EDU 2 is on the bottom and EDU 1 is on the top. The OE loom has white tape marking EDU 1.

The ARMAX loom connects to the grey 8 pin plug on each EDU indicated in the photo.

NOTE: EDU location may vary with the fitment of aftermarket accessories such as a dual battery kit. If you are unsure about identifying them correctly please contact Safari 4x4 for further information

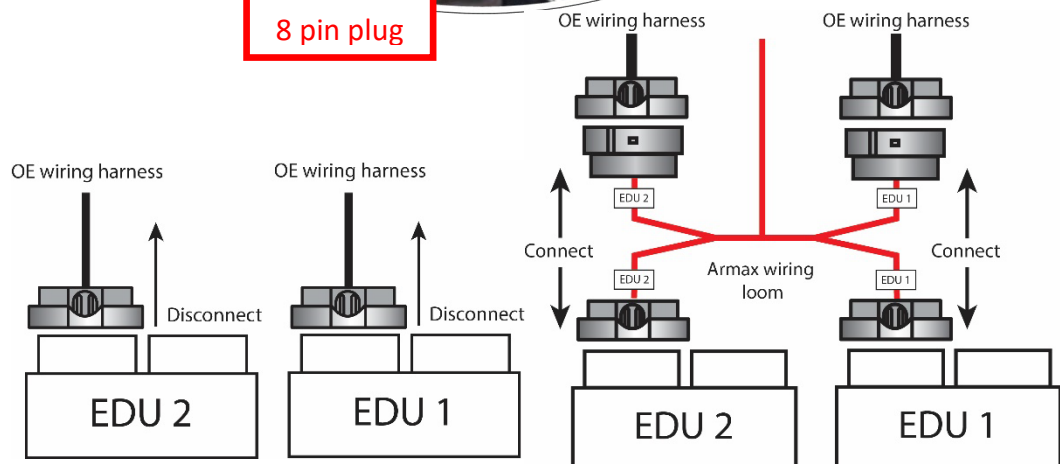
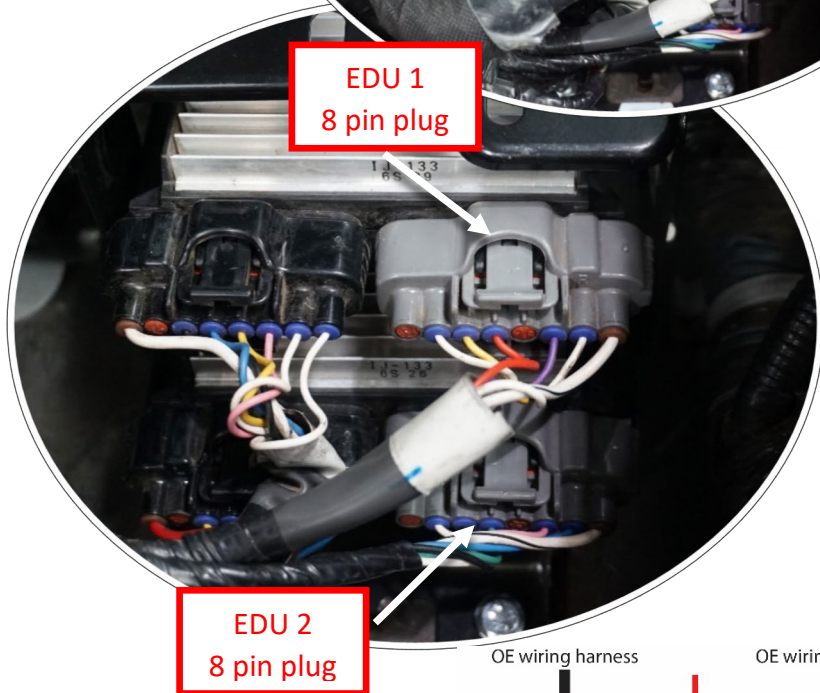
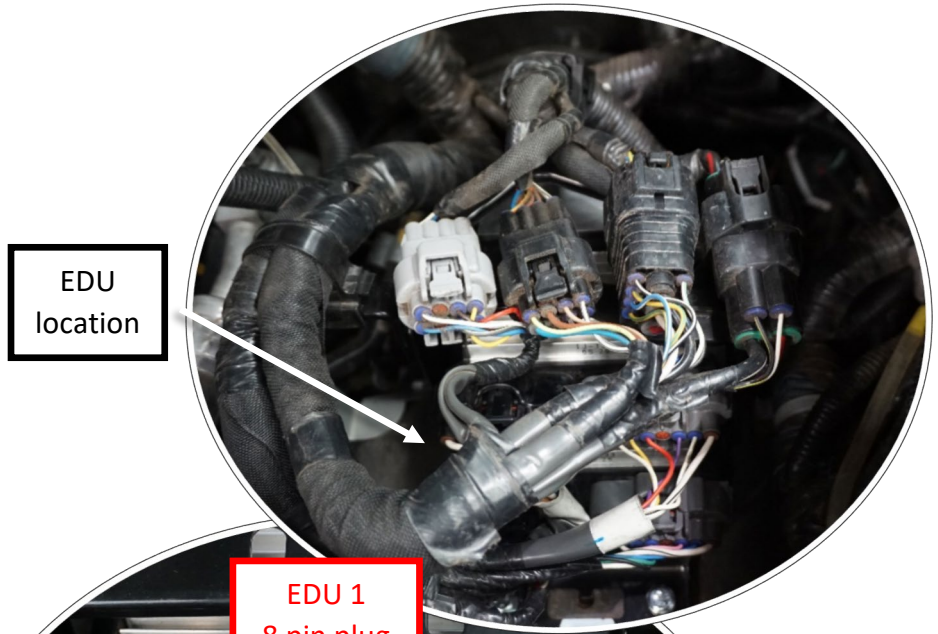

Route the Battery branch of the ARMAX loom along the firewall and inner guard to the main vehicle battery (see photo).

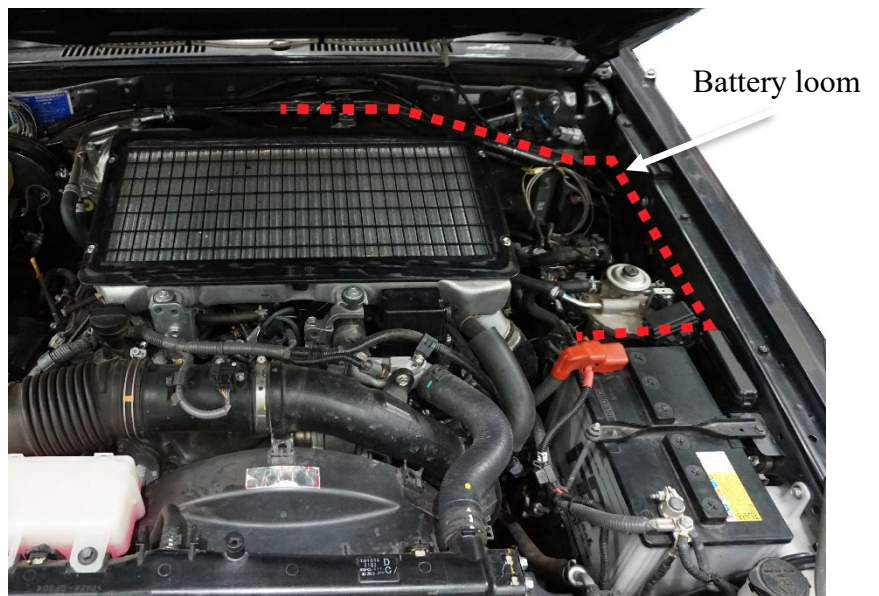

Connect the battery branch of the ARMAX loom to the positive and negative terminals of the main vehicle battery.



32 Install the EGT thermocouple into the clamp assembly.

Using a ruler measure the distance between the top of the EGT thermocouple and the clamp.

Set the distance according to diameter of the engine pipe at the back of the turbo (see diagram).

Once in position tighten the nut onto the clamp. When the nut is fully tightened the ferrule will lock the thermocouple into position.

Remove the thermocouple from the clamp

IMPORTANT

NOTE: The EGT depth is critical to the performance of the ECU. Ensure the depth is set correctly.

EGT thermocouple and clamp assembly

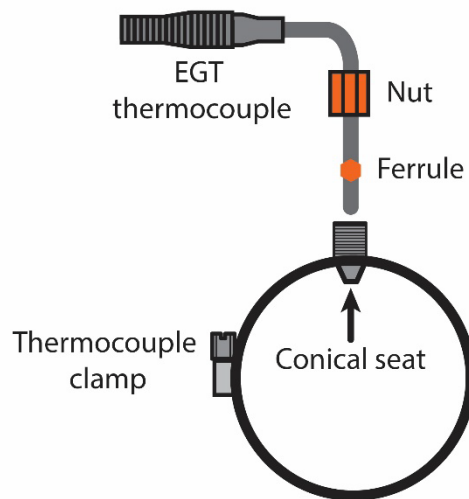

Standard engine pipe

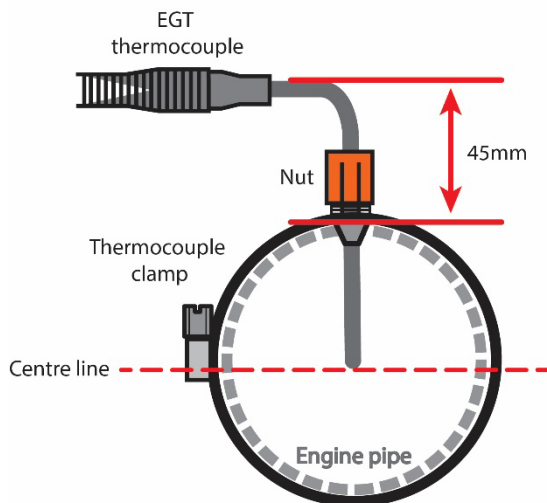

33

Remove rear section of inner guard liner from LHF wheel arch.

Remove



34

Mark location on LH engine pipe to be drilled for EGT thermocouple.

Centre punch and drill a 7mm hole where marked in LH engine pipe.

Mark

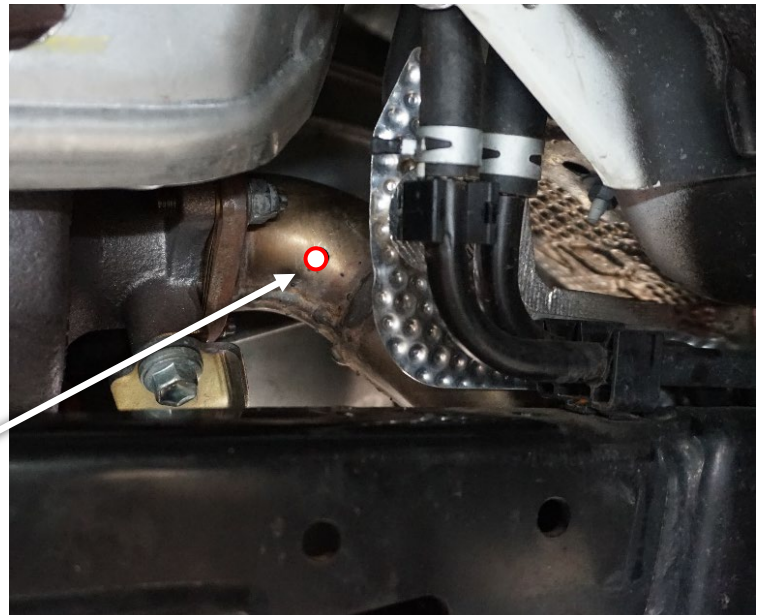

35

Install thermocouple clamp to engine pipe and tighten. Ensure the conical seat is aligned with 7mm hole

Cut off excess band from thermocouple clamp once tight. Fold over cut section of clamp to avoid sharp edge.

Thermocouple clamp

Cut

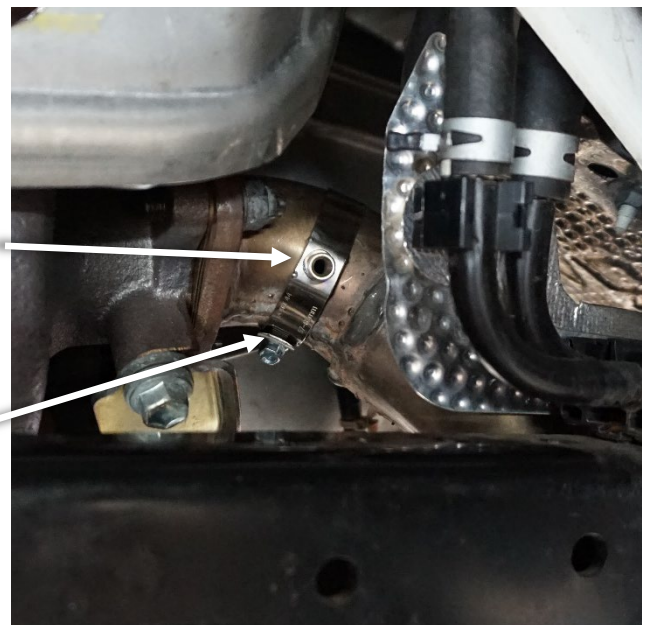

36

Install the EGT thermocouple into the clamp noting the orientation shown and tighten.

Reinstall inner guard cover.

EGT Thermocouple

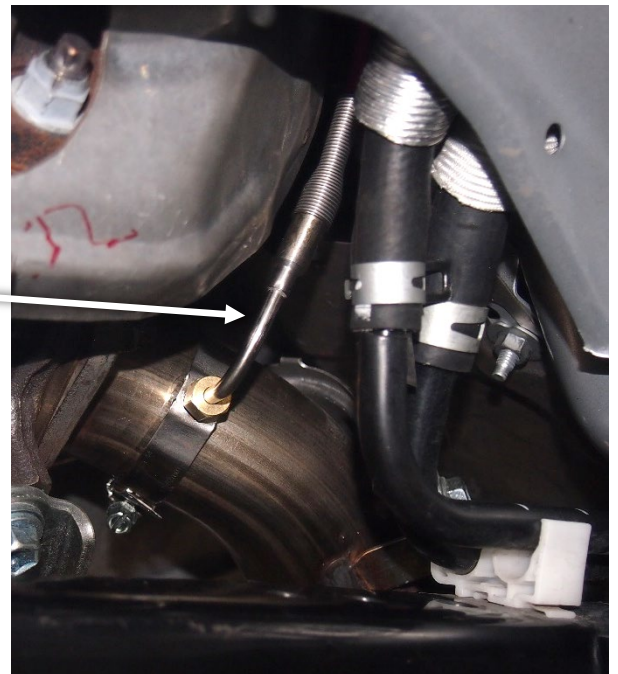

37

Route EGT wire along the firewall to the ECU

38

Install the DTM mounting clip onto the 2 pin EGT plug on the ARMAX loom.

Mount EGT connector to mounting bracket D.

Connect EGT wire to the ARMAX loom

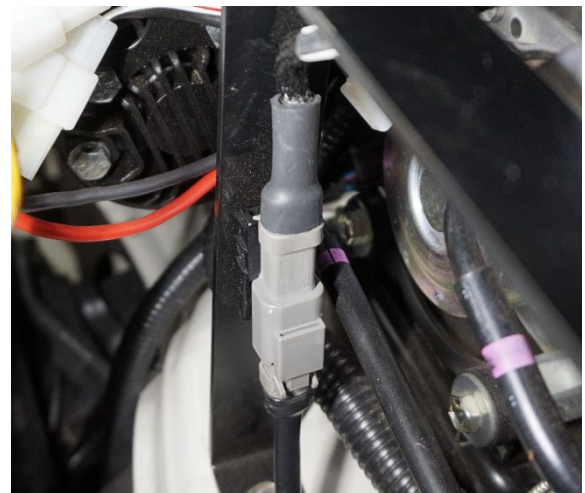
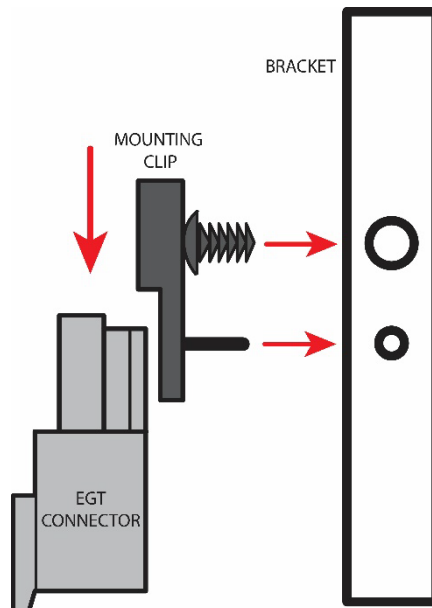

39

Use the supplied cable ties to secure the ARMAX loom and EGT wire to the firewall.

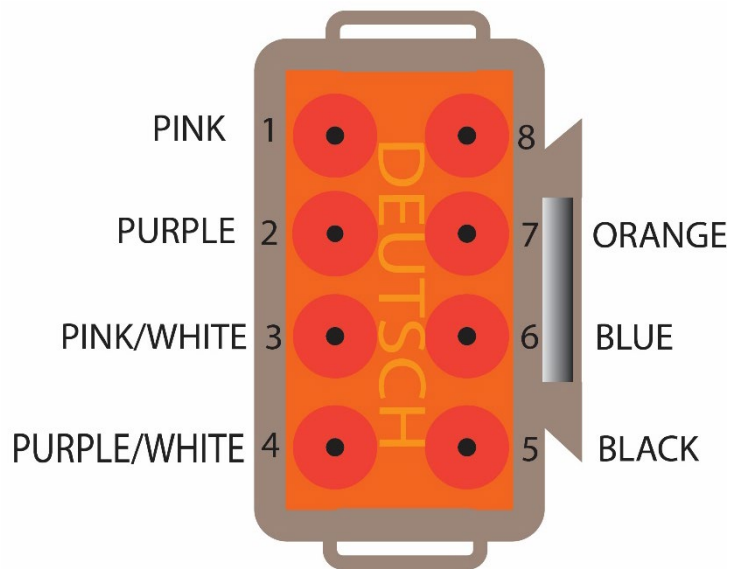

Locate the main harness in the driver's side footwell labelled IN CAR LOOM.

Use the diagrams to insert the terminals on the main harness into the DTM connector.

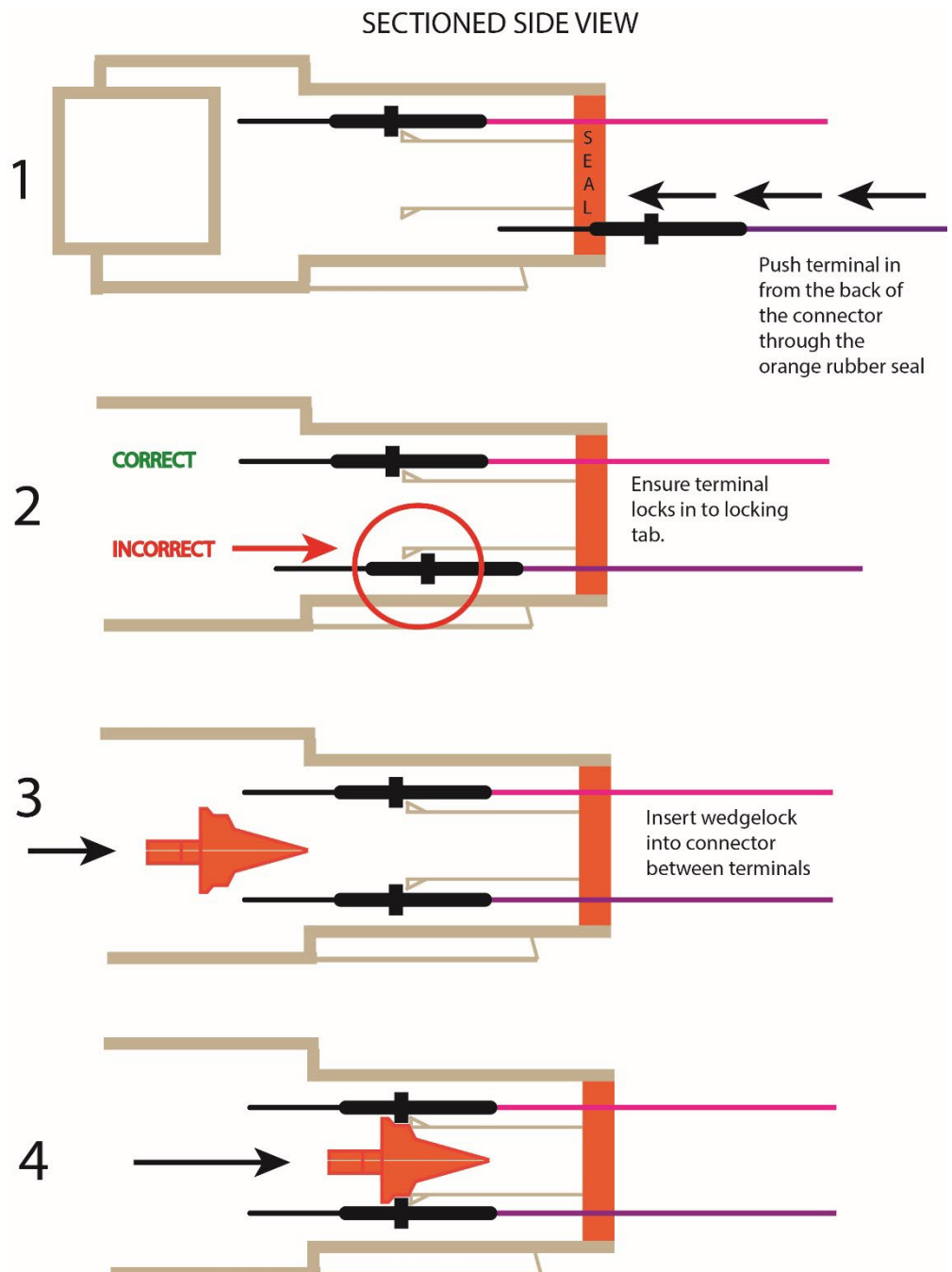

41 Connect the IN CAR LOOM (secondary harness) to the DTM connector on the main harness.

Check that the wire colours all correspond with each other.

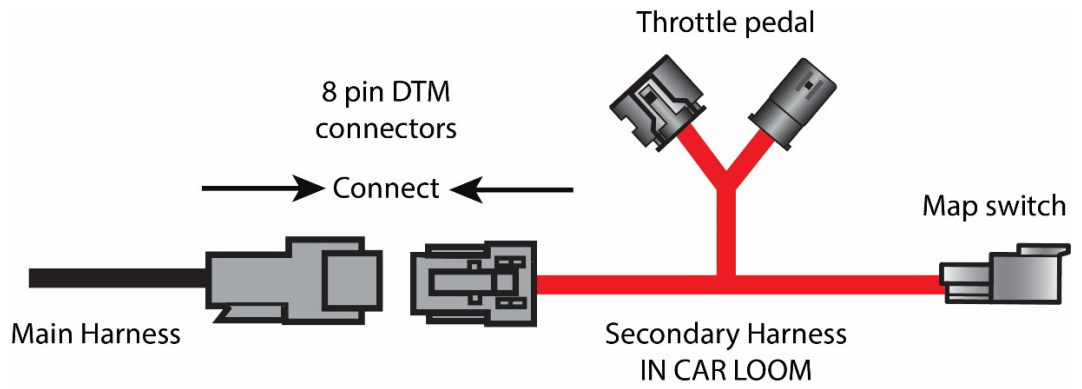

42

Connect the IN CAR LOOM to the throttle pedal sensor connector.

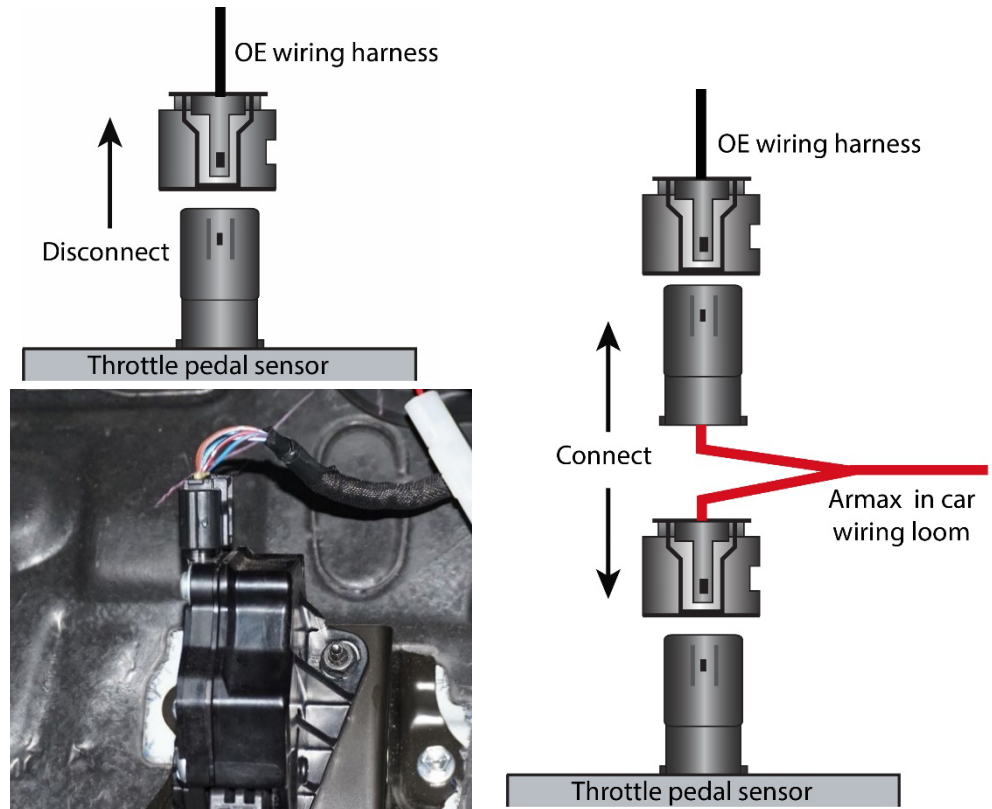

43

Remove the adhesive backing cover from the map select switch and mount in a position that the driver is comfortable with.

Ensure that it is on a flat clean surface to allow for maximum adhesion.

Remove adhesive backing cover

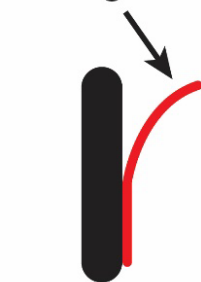

Map select switch

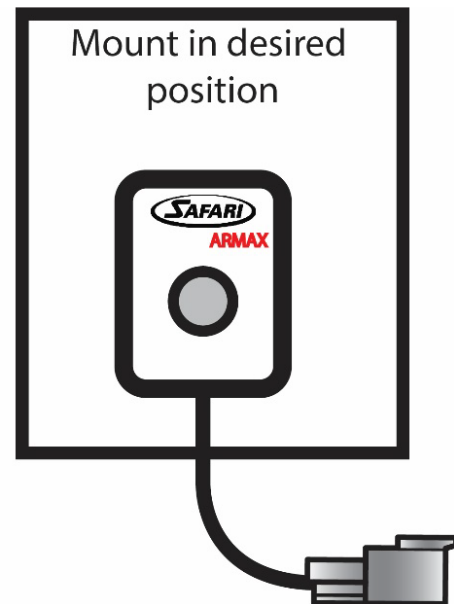

44 Connect switch to the IN CAR LOOM.

Neatly cable tie the IN CAR LOOM and any excess wire from the switch neatly in driver side foot well ensuring that it will not interfere with the drivers feet.

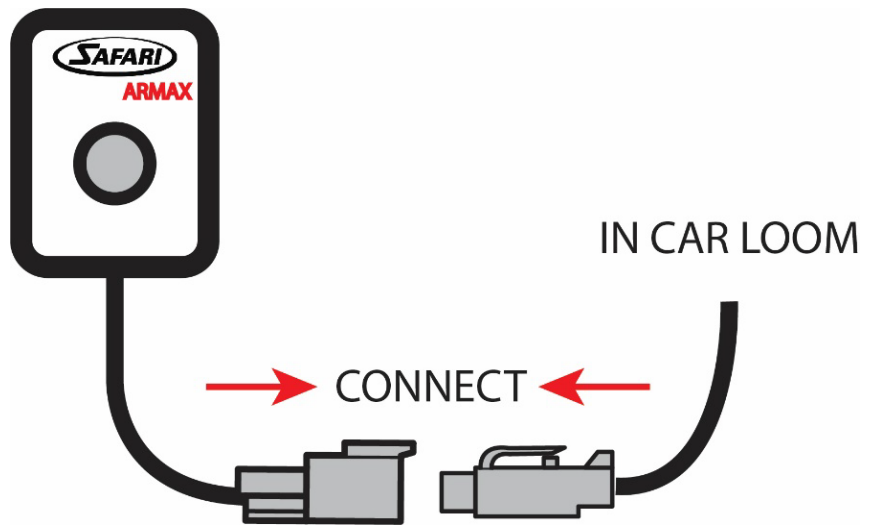

45 Final fitment checklist:

- Check all ECU mounting hardware is tight.
- Check the loom is secure and not in contact with the engine or exhaust.
- Check all connections are correct.
- Check EGT is connected and the thermocouple probe depth is correct.
- **Reconnect the vehicle battery.**
- Check the Armax ECU diagnostics.
- **Place the user manual and bridge out connector in the glove box of the vehicle.**

Contact Safari 4x4 engineering to get the correct tune file installed into the vehicle. **DO NOT START/DRIVE THE VEHICLE UNTIL THE TUNE FILE HAS BEEN UPDATED!!**

- 46 Once the new tune file has been loaded into the Armax ECU, the DVVC System can be Activated as shown by :
1. Unplugging the boost control solenoid from the Standard vehicle harness and plugging it into the Safari Armax ECU harness as shown.
 2. Unplugging the blanking cap and moving it from Armax ECU harness plug to the Standard vehicle harness plug as shown.

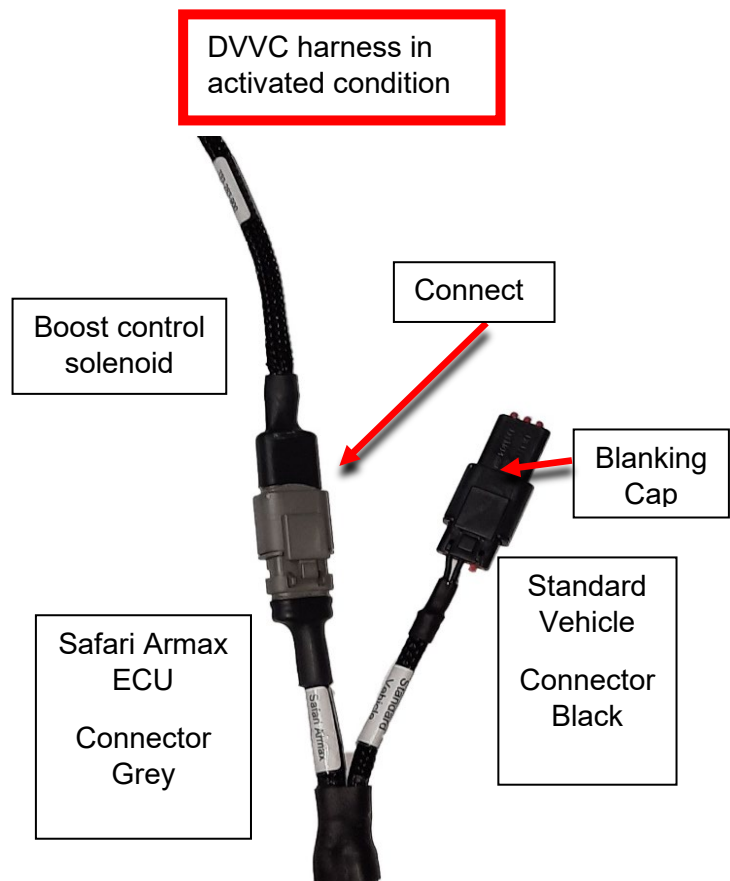

Test drive checklist:

- Start vehicle and ensure there are no engine/warning lights.
- Check that the engine is operating as normal (not missfiring/making unusual sounds).
- Check that the switch illuminates and cycles through the different maps
- Drive the vehicle ensuring it reaches **full operating temperature** (the ECU will not operate at its full potential until this is reached). Drive the vehicle on different maps and check that the ECU operates correctly.

Record a log file of the vehicle and E-Mail it to: Support @Safari4x4.com.au so the file can be checked and approval given for the vehicle to be released to the customer.