



**4X4 ENGINEERING**

# SS156HF

SAFARI V-SPEC SNORKEL  
To Suit: TOYOTA FORTUNER (Oct 2015 onwards)  
2.8L Turbo Diesel D-4D (1GD-FTV Engine)



10/05/2017

## Parts List

ITEM	PART NO.	DESCRIPTION	QTY
1	322-133-400	BODY - SNORKEL (SS156HF)	1
2	000-135-800	3 1/2" AIR RAM ASSEMBLY	1
3	322-032-200	BRACKET - UPPER MOUNTING	1
4	000-002-100	BOLT - HEX - 6mm x 1.0 x 14mm (SEMS)	2
5	000-951-300	SCREW - S/T - 4.2mm x 16mm - S/S	3
6	000-960	INSERT - PLASTIC	3
7	000-110	STUD - 8mm x 1.25 x 25mm - S/S	6
8	000-311-300	WASHER - BODY - 8mm x 30mm - S/S	6
9	000-205-300	NUT - NYLOC - 8mm x 1.25mm - S/S	6
10	322-024-400	HOSE - AIR ENTRY	1
11	000-910	CLAMP - HOSE - 90/110mm	2
12	000-914/B	CLAMP - HOSE - SIZE 56 (BLACK)	1
13	322-017-400	TEMPLATE - GUARD PANEL	1



**4X4 ENGINEERING**

# SS156HF

SAFARI V-SPEC SNORKEL

To Suit: TOYOTA FORTUNER (Oct 2015 onwards)  
2.8L Turbo Diesel D-4D (1GD-FTV Engine)

## Installation Guide

### Fitment to:

- Right Hand Side

### Fitting Time:

- 120min

### Special Tools:

- Body Saw (reciprocating)
- Step Drill
- Files
- Loctite 243 (thread lock)
- Masking Tape
- Touch-up paint

**Prior to commencing the installation, it is the installer's responsibility to verify that all components and particularly the template (Item 13) are correct.**

1

Remove the following in accordance with the factory service manual:

- Air Cleaner Assembly
- RHS Mud Flap
- RHS Guard Liner
- RH Guard Mount Indicator (if fitted to vehicle)
- RH Guard Upper Plastic Trim

Remove



Remove and discard:

- Air intake ducting
- Air Deflector



Remove and discard the perforated sections from the guard panel template (item 13) as shown.

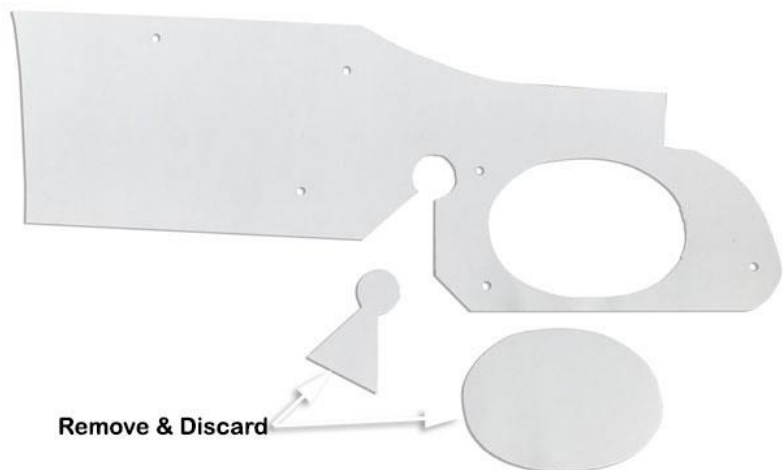

Align the guard panel template (Item 13) to the upper and rear edges of the right hand guard panel as shown.

Tape the template to the guard panel with masking tape.

Mark all hole positions and the cut-out section with a felt tip pen.

Remove the template.

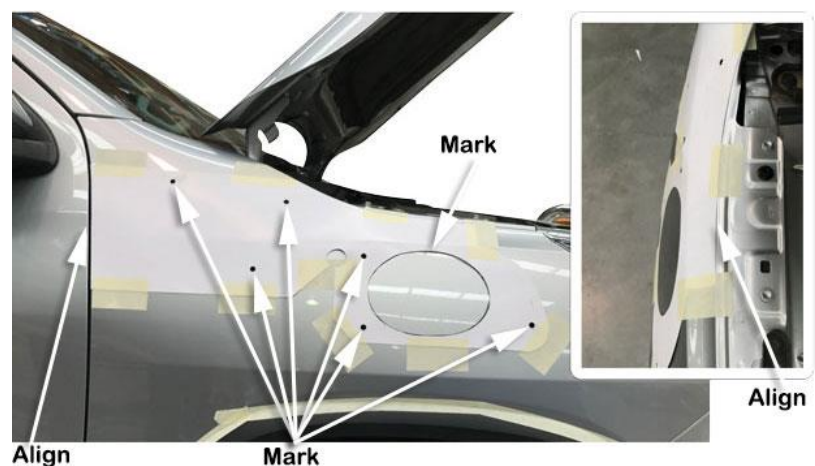

Drill a pilot hole for each of the marked positions.

Use a step drill to drill the 6 mounting holes to 16mm diameter.

Drill 2 or 3, 10mm diameter holes in the cut-out section for a start/stop point for the body saw, using the body saw cut the main hole in the guard panel (*care must be taken whilst cutting the main hole in the guard panel not to cut into the guard panel reinforcement*) as marked from the template cut-out in step 4.

Deburr and paint holes.

Hint: *prior to any cutting or drilling, place a strip of masking tape along the flare and guard panel to prevent metal filings being trapped between the flare and guard panel.*

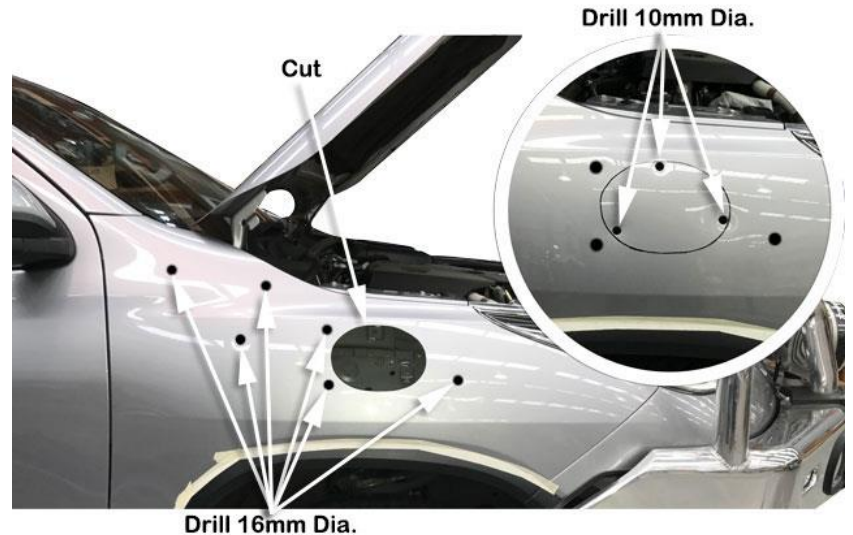

### NEW ZEALAND INSTALLATIONS ONLY :

Safari have developed 2 methods of Snorkel A pillar attachment, for the conventional method please proceed with the current document alternatively please see the link below for further instructions.

[www.safari4x4.co.nz/apillarmounting](http://www.safari4x4.co.nz/apillarmounting)

Install the upper mounting bracket (Item 3) to the snorkel body (Item 1) with hex bolts (Item 4).

Apply Loctite 243 to each of the stainless steel mounting studs (Item 7) and install the studs finger tight into the snorkel body (Item 1) mounting inserts as shown.

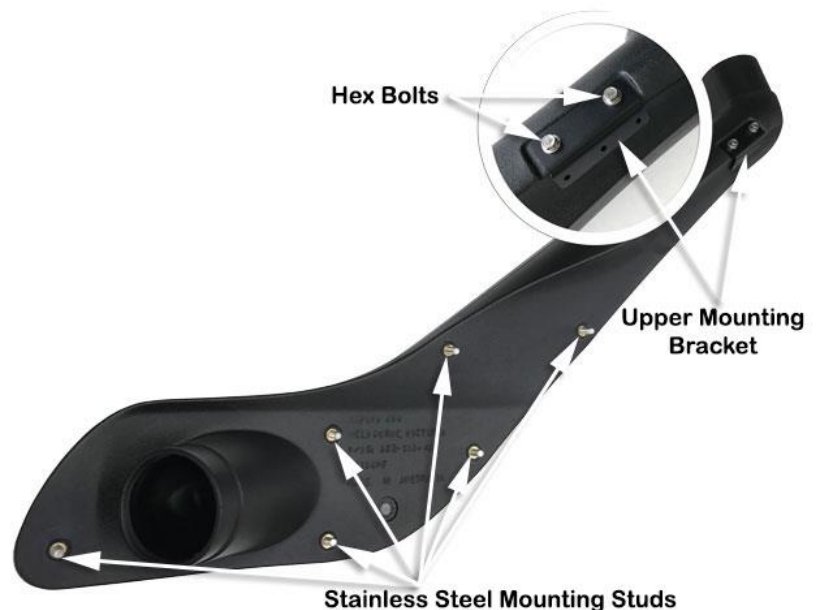



7

Place a strip of masking tape along the A-pillar panel.

Carefully install the snorkel body (Item 1) to the guard panel.

With the snorkel body correctly positioned on the vehicle, accurately mark the position of the upper mounting bracket (Item 3) onto the masking tape.



8

Remove the snorkel body (Item 1) from the vehicle and remove the upper mounting bracket (Item 3) from the snorkel body.

Position the upper mounting bracket (Item 3) onto the A-pillar and align the bracket with the marked bracket outline. Mark the three mounting hole positions with a felt tip pen.

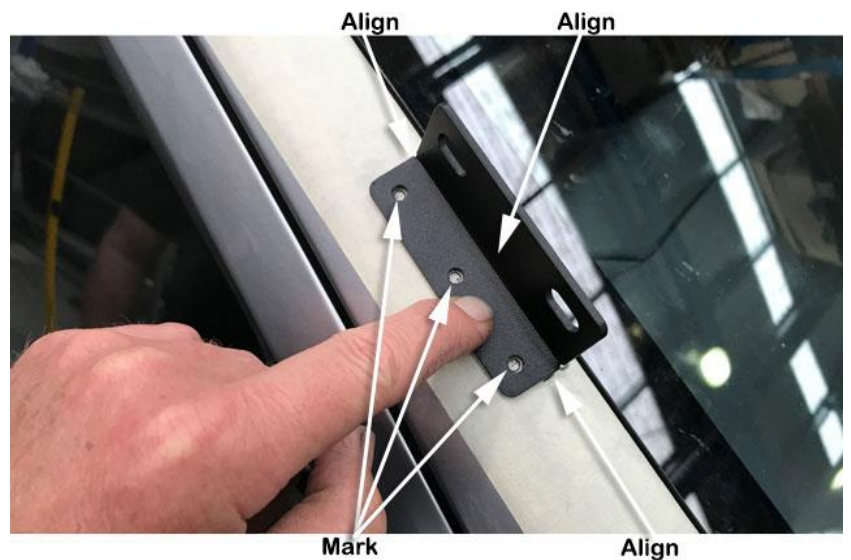

9

Drill a pilot hole at each of the three marked hole positions. Drill each hole position to 8mm diameter with a step drill or 8mm drill bit.

Deburr and paint holes.



10

Install the plastic inserts (Item 6) into the 8mm diameter holes in the A-pillar.

Secure the upper mounting bracket (Item 3) to the A-pillar with three self-tapping screws (Item 5).



11

Scribe a line around the pre-spinner flange as shown.

Carefully remove the pre-spinner assembly from the air cleaner base, using the body saw cut along the scribed line removing the outer section of the pre-spinner flange.

Neaten the cut with a file or grinder.

Re-install the pre-spinner and file/grind off the two locating tabs so the tabs are flush with the air cleaner inlet.



12

**INSTALLER OPTION :**

The air cleaner base contains a drain valve and drain hole as shown. The drain valve and drain hole can permit water to enter the air intake.

Safari advises that the drain valve and drain hole should be sealed to ensure a watertight installation.

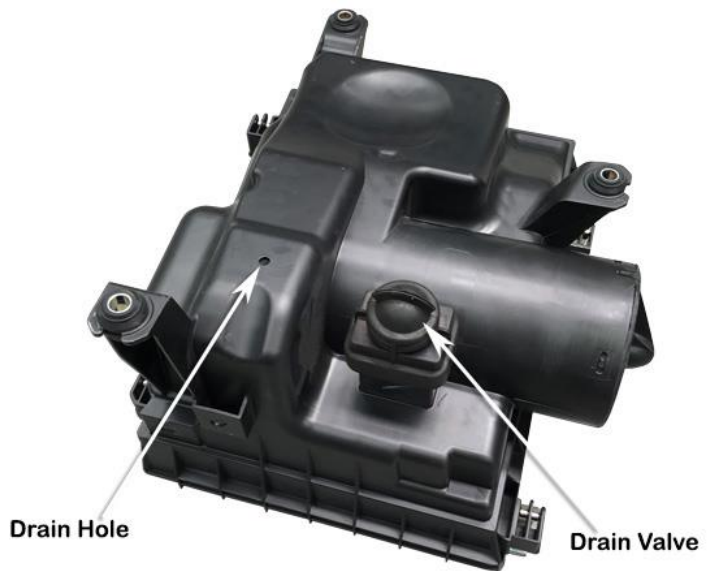



Install the air entry hose (item 10) through the hole in the inner guard panel, loosely install a 90/110mm hose clamp (item 11) onto either end of the air entry hose.

Re-install the air cleaner base, guiding the air cleaner inlet into the air entry hose, fasten the air cleaner base using standard mounting bolts.

Rotate and align the air entry hose (item 10) with the main hole in the guard panel.



Carefully install the snorkel body (Item 1) to the guard panel, guiding the snorkel body outlet snout into the air entry hose (item 10), align the snorkel body to guard panel and upper mounting bracket.

When correctly aligned, fasten the snorkel body to the guard panel with body washers (Item 8) and nyloc nuts (Item 9).

Fasten the snorkel body to the upper mounting bracket with hex bolts (Item 4).



15

Align the air entry hose for best fitment (*Ensure the air entry hose is installed hard up against the shoulder of the snorkel body outlet*), correctly position the 90/110mm hose clamps at either end of the air entry hose and tighten the hose clamps.

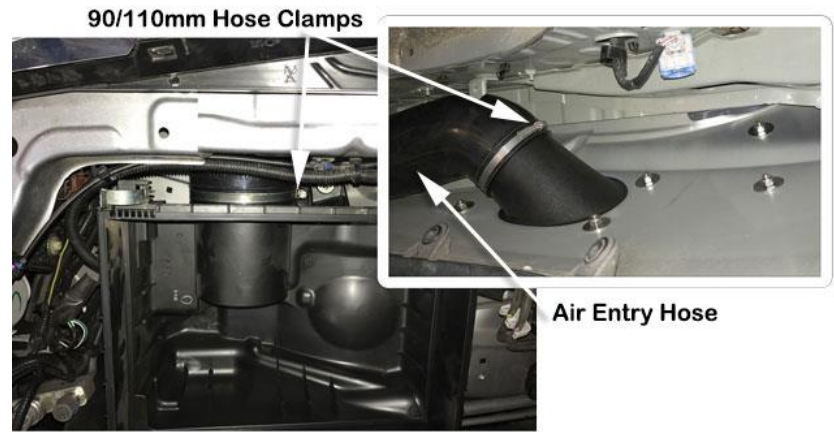

16

Loosely install the black hose clamp (Item 12) over the base of the air ram assembly (Item 2).

Install the air ram assembly onto the snorkel body.

Align the air ram assembly and tighten the black hose clamp (Item 12).



17

Install the guard mounted indicator (if fitted to vehicle), guard liner, mud flap, plastic guard trim, air cleaner element, air cleaner lid, reconnect sensor wiring and any other items that may have been removed during the snorkel installation process.

18

**N.B: It is the installer's responsibility to ensure that all connections are water tight.**