

SS15HFD SAFARI V-SPEC SNORKEL

Nissan GU Patrol Series 1
4.2L 6 Cyl Diesel (TD42 Engine)



01/03/2012

Parts List

ITEM	PART NO	DESCRIPTION	QTY
1	485-133-500	BODY - SNORKEL (SS15HFB)	1
2	000-135-800	3 1/2" AIR RAM ASSEMBLY	1
3	485-032-500	BRACKET - UPPER MOUNTING	1
4	000-002-100	BOLT - HEX - S/S - 6mm x 1.0 x 14mm (SEMS)	2
5	000-951	SCREW - S/T - S/S - 4.2mm x 13mm	3
6	000-960	INSERT - PLASTIC	3
7	000-110	STUD - S/S - 8mm x 1.25 x 25mm	5
8	000-311-300	WASHER - BODY - S/S - 8mm x 32mm	5
9	000-205-300	NUT - NYLOC - S/S - 8mm x 1.25mm	5
10	485-024-000	HOSE - SNORKEL OUTLET	1
11	485-025-000	JOINER - 90mm OD x 60mm Long	1
12	485-024-200	HOSE - AIR CLEANER ENTRY	1
13	485-025-200	JOINER - 90mm OD x 48mm Long	1
14	485-024-400	ADAPTOR - 90mm ID x 152mm ID x 70mm Long (RUBBER)	1
15	000-909	CLAMP - HOSE 80/100mm	2
16	000-910	CLAMP - HOSE 90/110mm	2
17	000-1911	CLAMP - HOSE 100/120mm	1
18	000-1916	CLAMP - HOSE 150/170mm	1
19	000-914/B	CLAMP - HOSE - No. 56 (BLACK)	1
20	000-434-030	FOAM TAPE - 25mm x 300mm	1
21	485-017-500	TEMPLATE - GUARD PANEL	1

Installation Guide

Fitment to:

- Left Hand Side

Fitting Time:

- 150min

Special Tools:

- 95mm & 111mm Hole saws
- Step drill
- Touch-up paint
- Loctite 243 (Threadlocker)
- Scriber
- Masking tape
- Body Saw (Reciprocating) / Hacksaw
- Adhesive sealant (Sikaflex 227)

Prior to commencing the installation, it is the installer's responsibility to verify that all components and particularly the template (Item 21) are correct.

1 Remove the following in accordance with the factory service manual.

- LHS Guard Liner
- LHS mudflap
- LHS Indicator Assembly
- Pre Cleaner Assembly
- Radio Antenna (if fitted)
- Air Cleaner Inlet Duct

2

Align the guard panel template (item 21) with the upper and rear edges of the LHS guard panel. Tape the template to the guard panel with masking tape.

Mark all hole positions with a felt tip pen and remove the template.

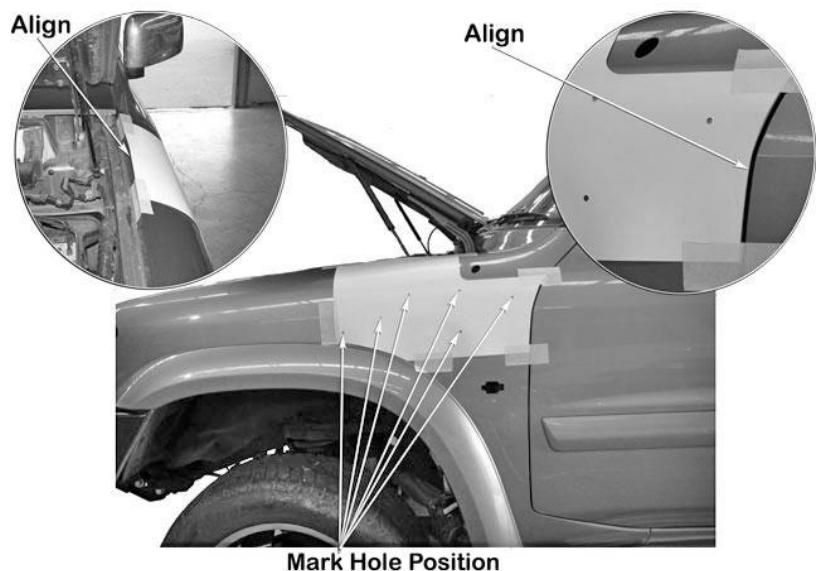

3

Drill a pilot hole for each of the marked hole positions.

Use a 111mm diameter hole saw to drill the snorkel body outlet hole position in the guard panel.

Use a step drill to drill the five mounting holes to 16mm diameter.

Deburr and paint holes to prevent rust.

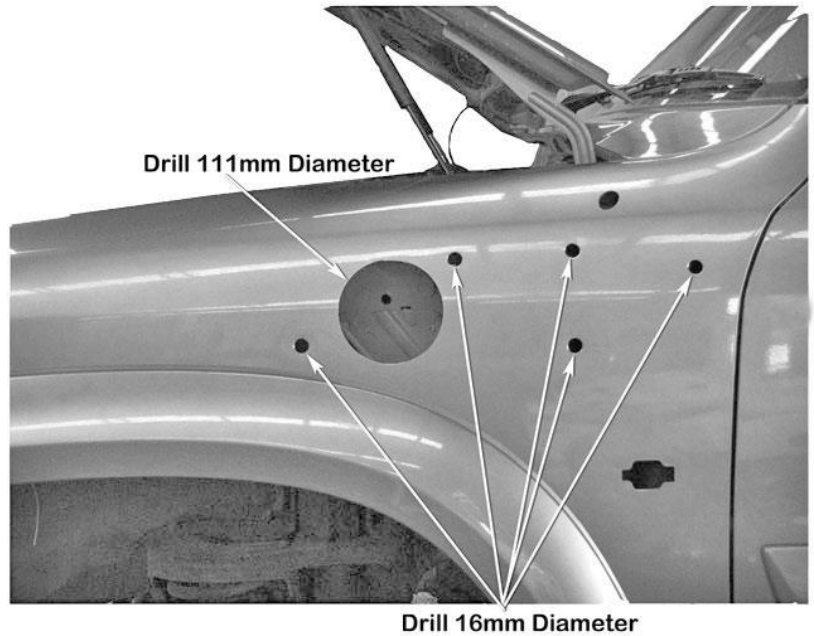

4

Use the 95mm hole saw to drill the hole through the internal panel, using the standard air intake hole in the inner guard as a guide for the 95mm hole saw whilst drilling.

Hint: Insert a piece of timber through the indicator hole to prevent the guard panel being damaged from the holesaw.

Deburr and paint hole to prevent rust.

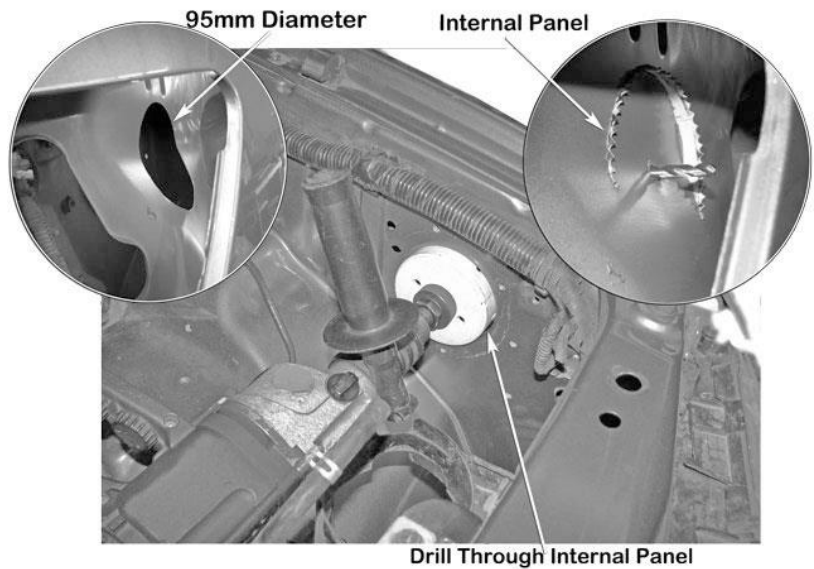

NEW ZEALAND INSTALLATIONS ONLY :

Safari have developed 2 methods of Snorkel A pillar attachment, for the conventional method please proceed with the current document alternatively please see the link below for further instructions.

www.safari4x4.co.nz/apillarmounting

5

Install the upper mounting bracket (item 3) to the snorkel body (item 1) with hex bolts (item 4).

Apply Loctite 243 to each of the stainless steel mounting studs (item 7) and install the studs finger tight into the snorkel body (item 1) mounting inserts.

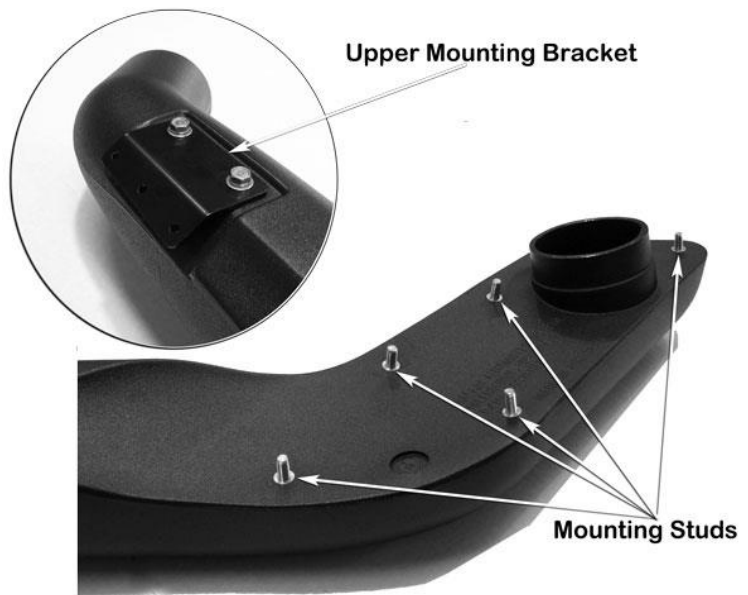

6

Place a strip of masking tape along the A-pillar panel.

Carefully install the snorkel body (item 1) to the guard panel.

With the snorkel body correctly positioned, use the scribe to mark the position of the upper mounting bracket (item 3) onto the masking tape as shown.



Remove the snorkel body (item 1) from the vehicle and remove the upper mounting bracket (item 3) from the snorkel body.

Position the upper mounting bracket onto the A-pillar and align the bracket to the scribe markings on the masking tape. Mark the three mounting hole positions with a felt tip pen.

Drill a pilot hole at each of the three marked hole positions. Drill each hole position to 8mm diameter with a step drill or 8mm drill bit.

Deburr and paint holes to prevent rust.

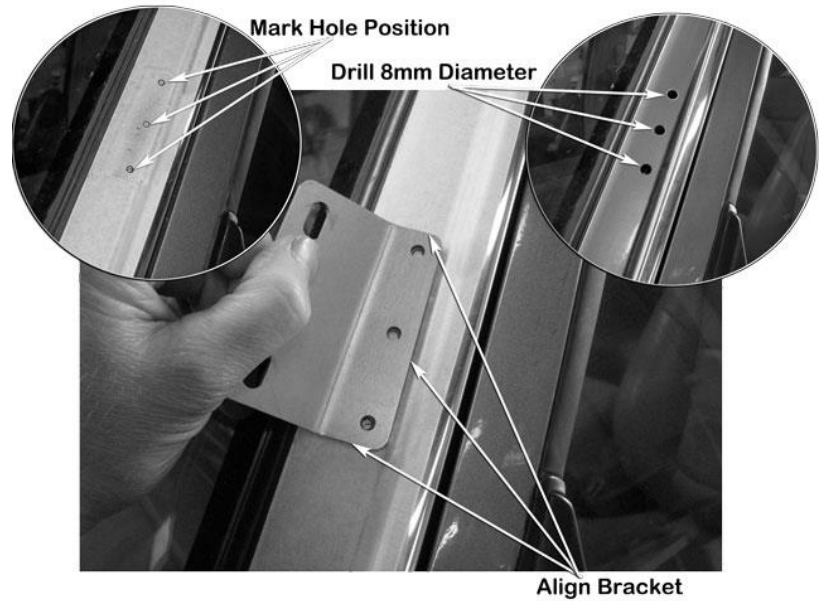

Install the plastic inserts (item 6) into the upper mounting bracket holes in the A-pillar.

Secure the upper mounting bracket (item 3) to the A-pillar with self tapping screws (item 5).

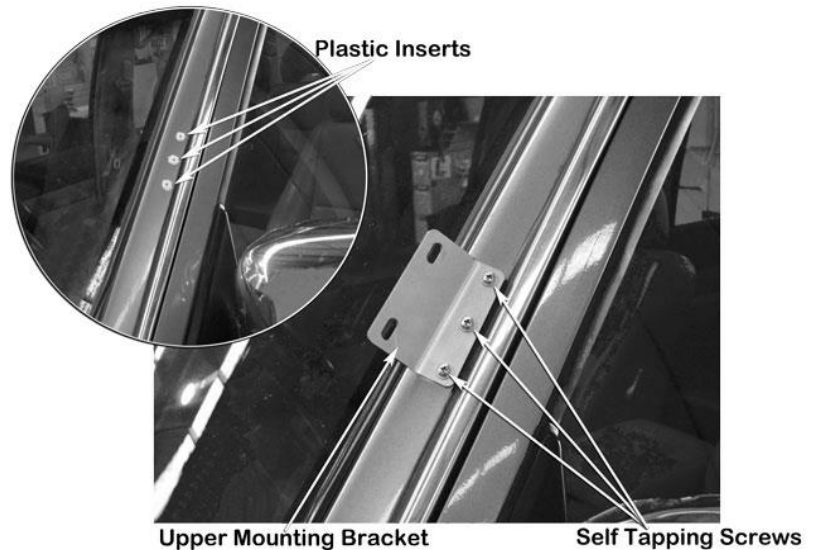

Install the air cleaner entry hose (item 12) through the 95mm diameter hole in the internal panel and the standard air intake hole.

Hint: Squash the end of the hose inwards and tape to hold whilst installing the hose through the holes as shown.



Measure and mark a line around the circumference of the 90mm diameter x 60mm long joiner (Item 11), 30mm in from the end.

Install the joiner into the air cleaner entry hose (Item 12) and align the 30mm mark to the end of the hose.

Secure the joiner in place with a 90/110mm hose clamp (Item 16).

Install the second 90/110mm hose clamp (Item 16) loosely over the joiner and install the snorkel outlet hose (Item 10) over the joiner (Item 11).

Do not tighten the hose clamp at this stage.

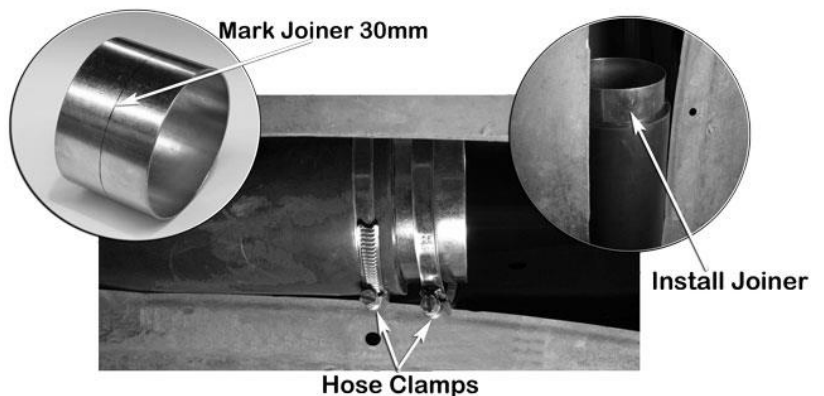

Install the 100/120mm hose clamp (item 17) loosely over the snorkel outlet hose (item 10) and align the hose with the hole in the guard panel.

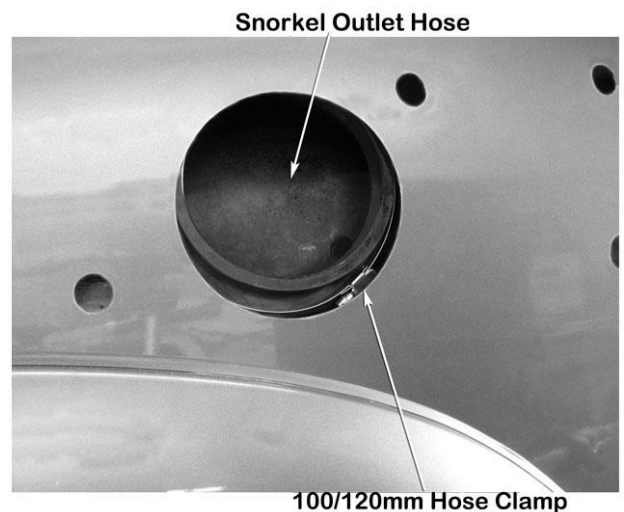

12

Carefully install the snorkel body (item 1) to the guard panel guiding the snorkel body outlet snout into the snorkel outlet hose (item 10), align the snorkel body to the guard panel and upper mounting bracket.

When correctly aligned fasten the snorkel body to the guard panel with body washers (item 8) and nyloc nuts (item 9).

Fasten the snorkel body to the upper mounting bracket with hex bolts (item 4).



13

Measure and mark a line around the circumference of the pre-cleaner assembly approximately 72mm in from the inlet end.

Use a body saw or hacksaw to cut off the inlet end of the pre-cleaner at the marked position as shown.

Deburr and paint.

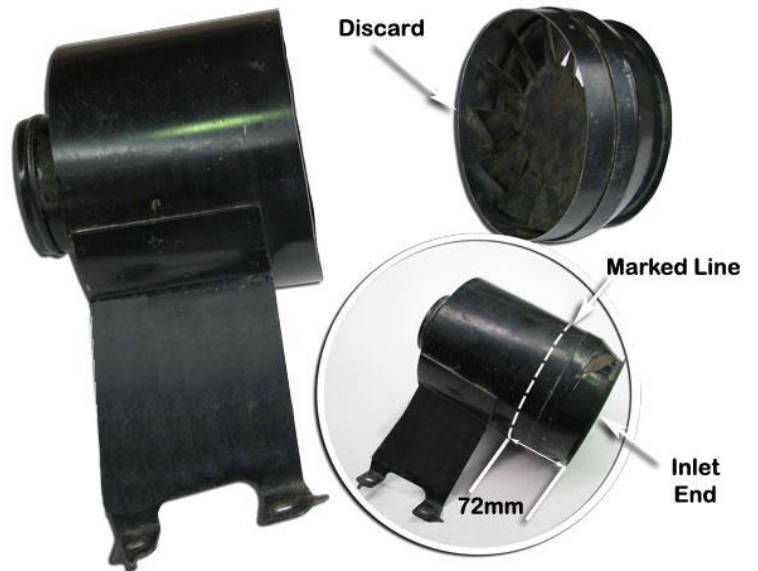

14

INSTALLER OPTION

The pre-cleaner assembly contains a drain valve. The drain valve can permit water to enter the air intake.

It is up to the installer to decide whether the drain valve should be sealed.



15

Install the 80/100mm hose clamp (item 15) loosely over the air cleaner entry hose (item 12).

Install the joiner (item 13) into the air cleaner entry hose and tighten the 80/100mm hose clamp.

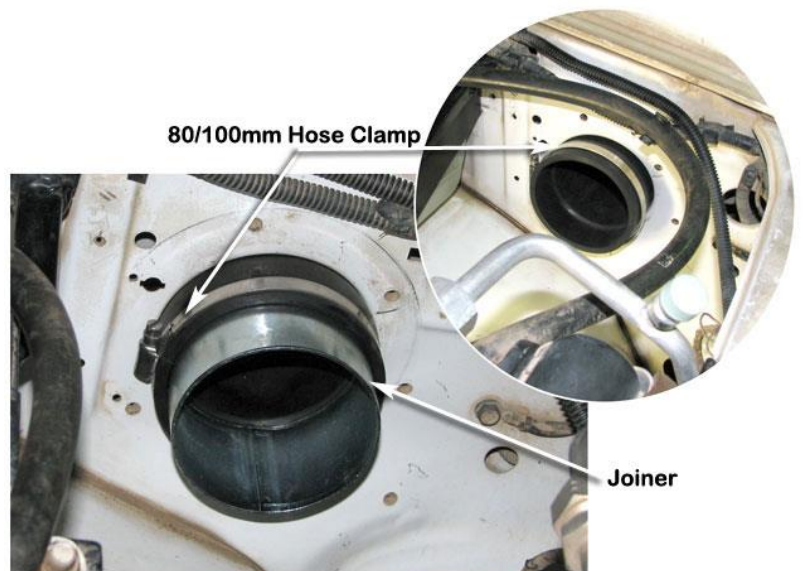

16

Install the rubber adaptor (item 14) to the pre-cleaner assembly, with the rubber adaptor correctly positioned, install the 150/170mm hose clamp (item 18) and tighten.



17

Loosely install a 80/100mm hose clamp (item 15) over the adaptor and install the pre-cleaner assembly into the vehicle, secure the pre-cleaner with the standard mounting fasteners.

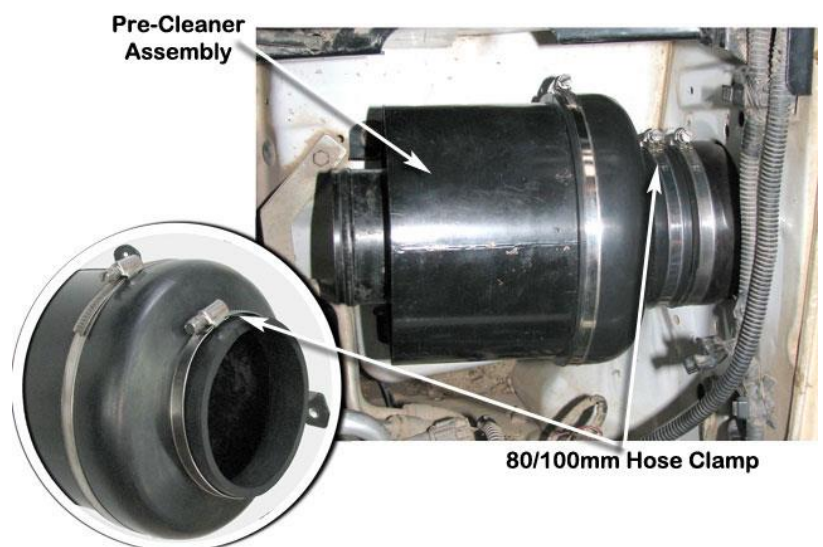

Align the two hoses (items 10 & 12) for best fitment, ensure that the snorkel outlet hose (item 10) is installed hard up against the shoulder of the snorkel body outlet snout, tighten the 100/120mm hose clamp (item 15).

Tighten the 90/110mm hose clamp at the joiner and the 80/100mm hose clamp at the rubber adaptor (item 14).

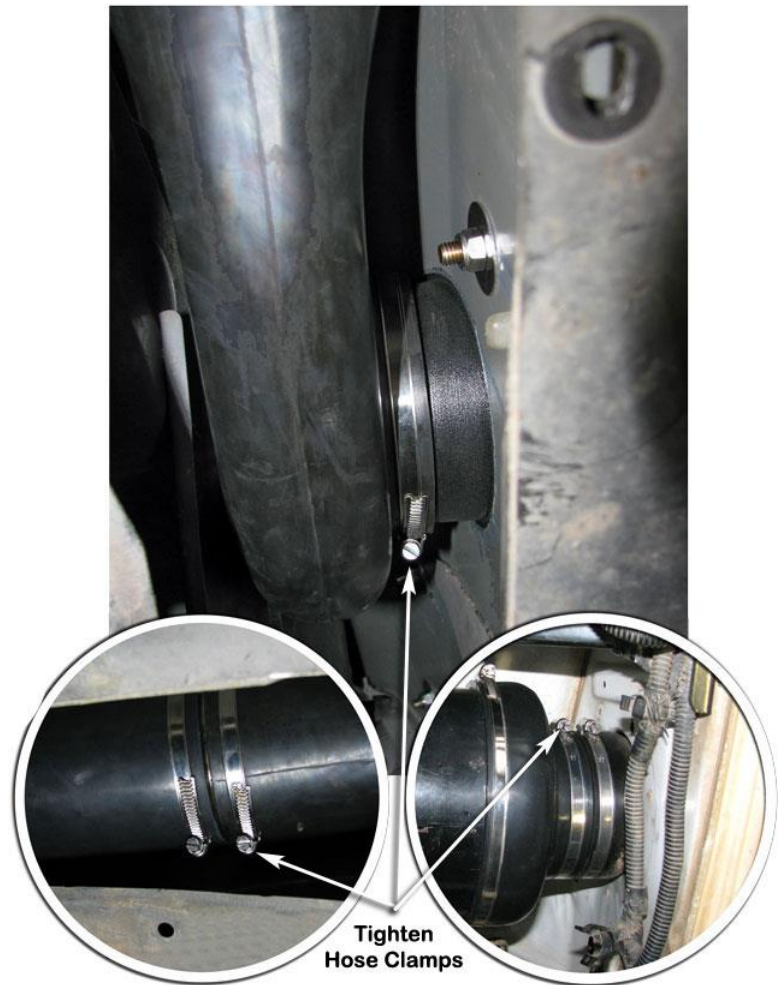

Remove the standard foam tape from the air cleaner housing inlet and replace with foam tape (item 20) supplied.

N.B: trim the foam tape to the required length.

Apply sealant to the foam tape and install the standard air duct.

N.B: clean-up any excess sealant for neat finish.

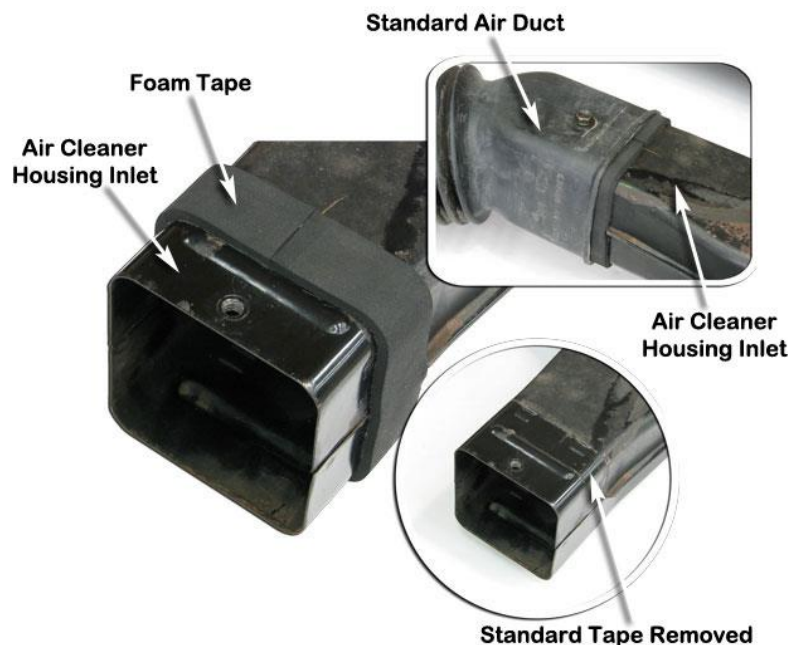

20

Apply sealant to the inside of the standard air duct and to the outside surface of the pre-cleaner housing outlet, install the standard air duct onto the pre-cleaner housing outlet, secure with the standard hose clamp.

N.B: Clean-up any excess sealant for neat finish.

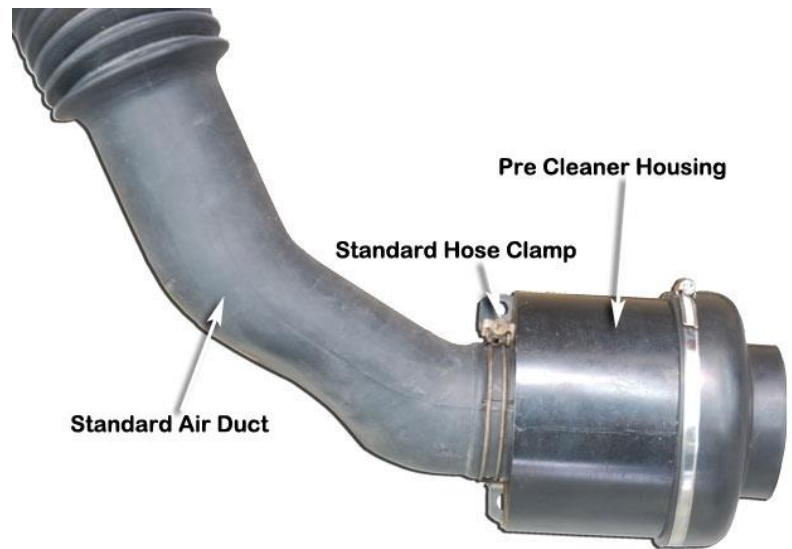

21

Install the black hose clamp (item 19) loosely over the base of the air ram assembly (item 2).

Install the air ram assembly onto the snorkel body.

Align the air ram assembly and tighten the black hose clamp (item 19).



22 Re-install the indicator assembly, radio antenna, guard liner, mud flap and any other items that may have been removed during the snorkel installation process.

23 **N.B: It is the installer's responsibility to ensure that all connections are watertight.**