

SS17HFB

SAFARI V-SPEC SNORKEL
Nissan GU Patrol Series 4 onwards
3.0L 4cyl Turbo Diesel (ZD30-DDTi Engine)



01/06/2017

Parts List

ITEM	PART NO.	DESCRIPTION	QTY
1	485-133-200	BODY - SNORKEL (SS17HF)	1
2	000-135-800	3 1/2" AIR RAM ASSEMBLY	1
3	485-032-000	BRACKET - UPPER MOUNTING	1
4	000-002-100	BOLT - HEX - 6mm x 1.0 x 14mm (SEMS) - S/S	3
5	000-951-300	SCREW - S/T - 4.2mm x 16mm - S/S	3
6	000-960	INSERT - PLASTIC	3
7	000-110	STUD - 8mm x 1.25 x 25mm - S/S	3
8	000-311-300	WASHER - BODY - 8mm x 32mm - S/S	3
9	000-205-300	NUT - NYLOC - 8mm x 1.25mm - S/S	3
10	485-024-100	HOSE - SNORKEL OUTLET	1
11	485-025-000	JOINER - 90mm OD x 60mm Long	1
12	485-024-300	HOSE - AIR CLEANER ENTRY	1
13	000-909	CLAMP - HOSE 80/100mm	3
14	000-910	CLAMP - HOSE 90/110mm	1
15	000-914/B	CLAMP - HOSE - No. 56 (BLACK)	1
16	485-017-200	TEMPLATE - GUARD PANEL	1

Installation Guide

Fitment to:

- Left Hand Side

Fitting Time:

- 120min

Special Tools:

- 108mm Hole saw
- Step drill
- Body Saw (Reciprocating) / Hacksaw
- Files
- Masking tape
- Loctite 243 (Threadlocker)
- Touch-up paint

Prior to commencing the installation, it is the installer's responsibility to verify that all components and particularly the template (Item 16) are correct.

1

Remove the following in accordance with the factory service manual.

- LHS Mudflap
- LHS Guard Liner
- Guard Mounted Indicator (if fitted)
- Radio Antenna (if fitted)
- Air Cleaner Assembly

2

Remove and discard the air intake ducting and foam isolator from the inner guard (shown).

Hint: The inner guard duct is retained to the internal panel by five M6 hex bolts and adhesive sealant.



3

Align the guard panel template (item 16) with the upper and rear edges of the LHS guard panel. Tape the template to the guard panel with masking tape.

Mark all hole positions with a felt tip pen and remove the template.

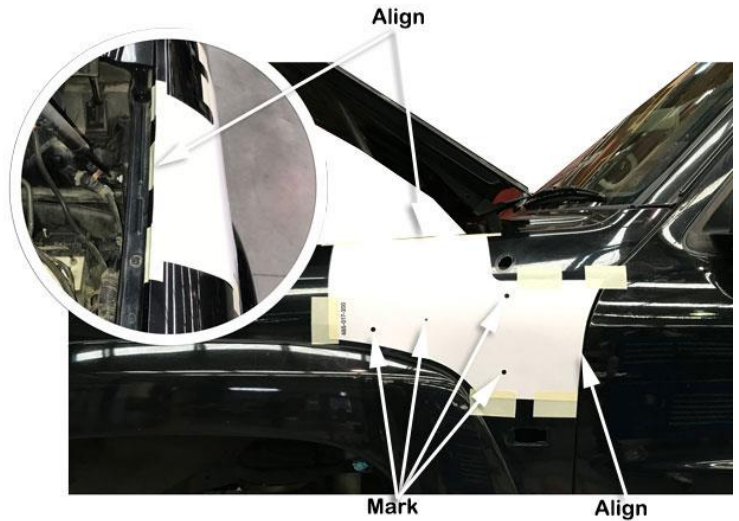

4

Drill a pilot hole for each of the marked hole positions.

Use a 108mm diameter hole saw to drill the snorkel body outlet hole position in the guard panel.

Use a step drill to drill the three mounting holes to 16mm diameter.

Deburr and paint holes to prevent rust.

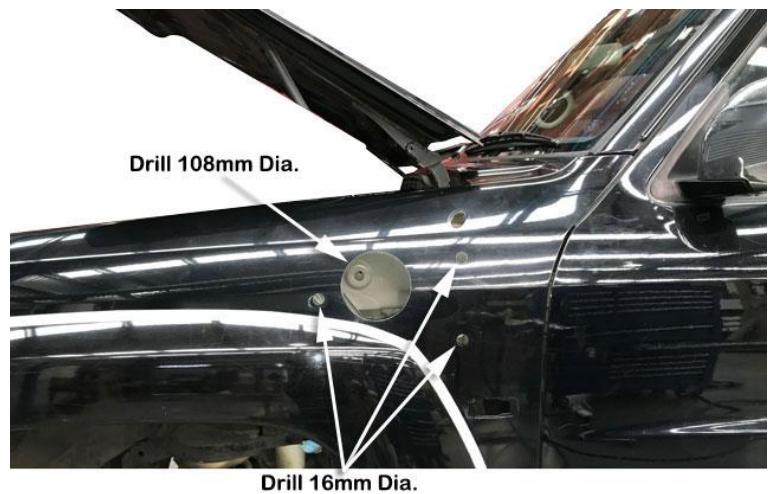

NEW ZEALAND INSTALLATIONS ONLY :

Safari have developed 2 methods of Snorkel A pillar attachment, for the conventional method please proceed with the current document alternatively please see the link below for further instructions.

www.safari4x4.co.nz/apillarmounting

5

Install the upper mounting bracket (item 3) to the snorkel body (item 1) with hex bolts (item 4).

Apply Loctite 243 to each of the stainless steel mounting studs (item 7) and install the studs finger tight into the snorkel body (item 1) mounting inserts.

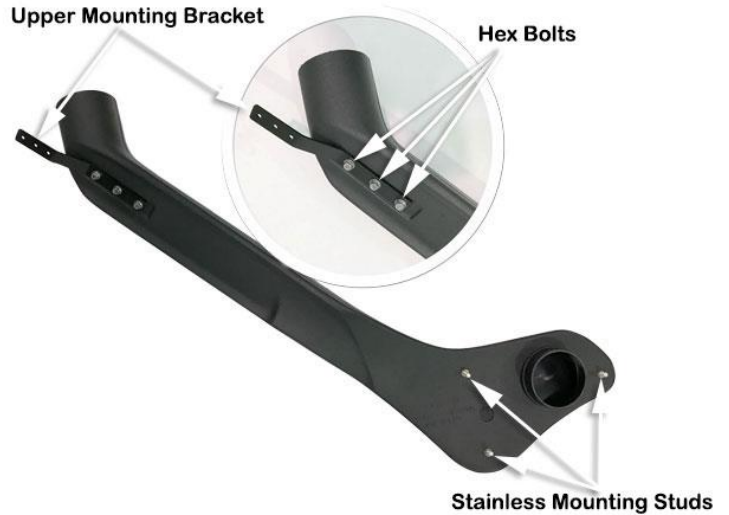

6

Place a strip of masking tape along the A-pillar panel.

Carefully install the snorkel body (item 1) to the guard panel.

With the snorkel body correctly positioned, mark the three upper mounting bracket hole positions onto the masking tape as shown.

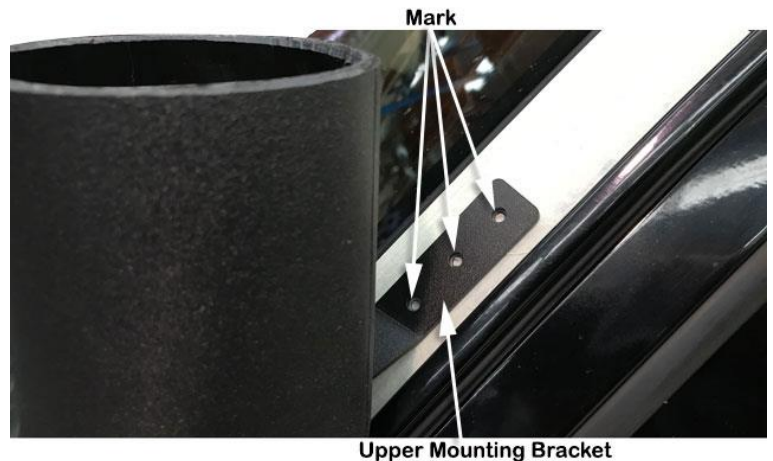

7

Remove the snorkel body (item 1) from the vehicle.

Drill a pilot hole at each of the three marked hole positions. Drill each hole position to 8mm diameter with a step drill or 8mm drill bit.

Deburr and paint holes to prevent rust.



Install the plastic inserts (item 6) into the 8mm diameter holes in the A-pillar.

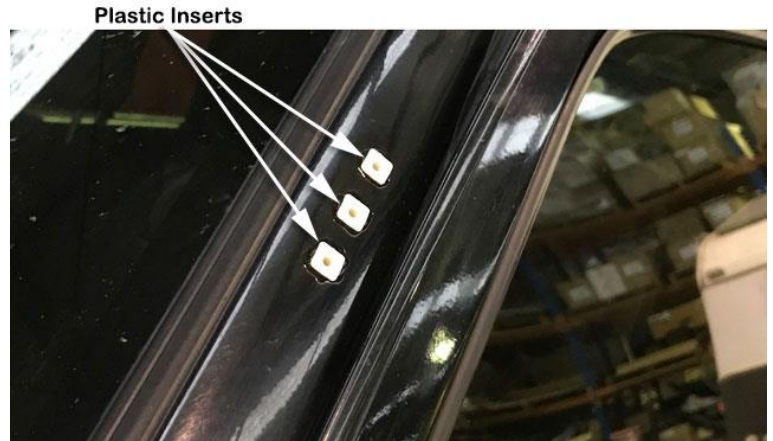

Install the air cleaner entry hose (item 12) through the hole in the internal panel and the air intake hole in the inner guard panel.

Hint: Squash the end of the hose inwards and tape as shown.

Apply CRC or similar lubricant to the external surface of the hose, install the hose through the holes in the inner guard panel as shown.

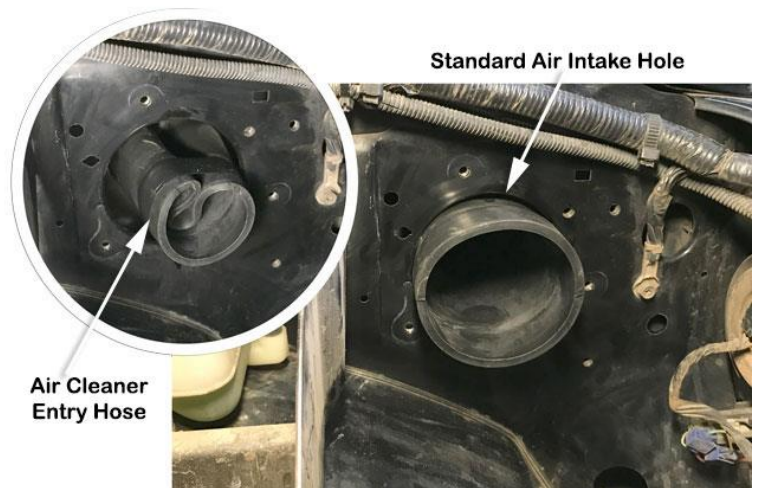

Mark the circumference of the joiner (item 11) 30mm from the end.

Install the joiner into the air cleaner entry hose (item 12) and align the 30mm mark to the end of the hose.

Install a 80/100mm hose clamp (item 13) onto the hose and tighten the clamp.

Note: the orientation of the hose clamp



11

Use a body saw / hacksaw to remove the flange and rib on the air cleaner base inlet, neaten the cuts with a file.

Ensure the air cleaner housing is free of any plastic filings from the cutting process.



12

INSTALLER OPTION

The air cleaner housing base contains one small drain hole. This hole can permit water to enter the air intake.

Safari advises that drain hole should be sealed to ensure a watertight installation.



13

Install the 80/100mm hose clamp (item 13) loosely over the air cleaner entry hose (item 12).

Apply CRC or similar lubricant to the inside of the air cleaner entry hose (item 12), install the air cleaner base whilst guiding the modified air cleaner snout into the air cleaner entry hose.

Secure the air cleaner base with the original mounting hardware.

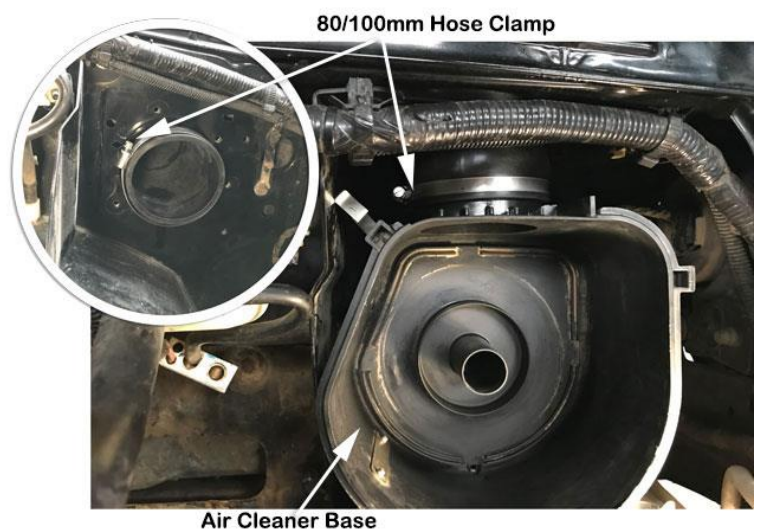

Loosely install the 80/100mm hose clamp (item 13) over the snorkel outlet hose (item 10), install the hose onto the joiner, loosely install a 90/110mm hose clamp to the snorkel body outlet end of the hose and align the hose with the hole in the guard panel.

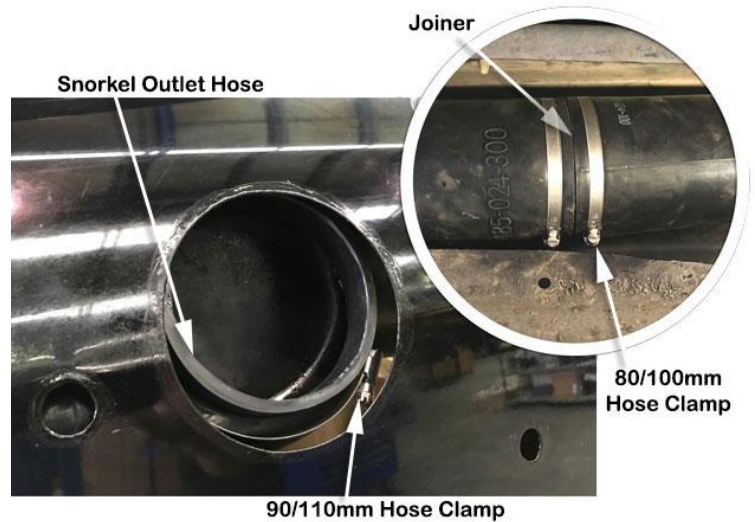

Apply CRC or similar lubricant to the inside of the snorkel outlet hose (item 10) and carefully install the snorkel body (item 1) to the guard panel guiding the snorkel body outlet snout into the snorkel outlet hose, align the snorkel body to the guard panel and the upper mounting bracket to the a-pillar mounting position.

When correctly aligned fasten the snorkel body to the guard panel with body washers (item 8) and nyloc nuts (item 9).

Fasten the upper mounting bracket to the A-pillar with self-taper screws (item 5).



Align the two hoses (items 10 & 12) for best fitment, ensure that the snorkel outlet hose (item 10) is installed hard up against the shoulder of the snorkel body outlet snout, tighten the 90/110mm hose clamp (item 14).

Tighten the 80/100mm hose clamps (item 13) at the joiner and the air cleaner entry.

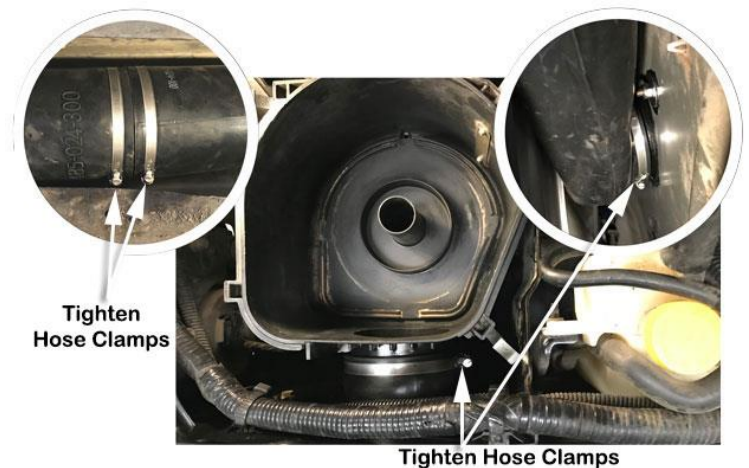

Install the black hose clamp (item 15) loosely over the base of the air ram assembly (item 2).

Install the air ram assembly onto the snorkel body.

Align the air ram assembly and tighten the black hose clamp (item 15).



Re-install the radio antenna, guard mounted indicator, guard liner, mud flap, air cleaner element, air cleaner lid, reconnect sensor wiring and any other components removed during the installation process.

N.B: It is the installer's responsibility to ensure that all connections are watertight.